

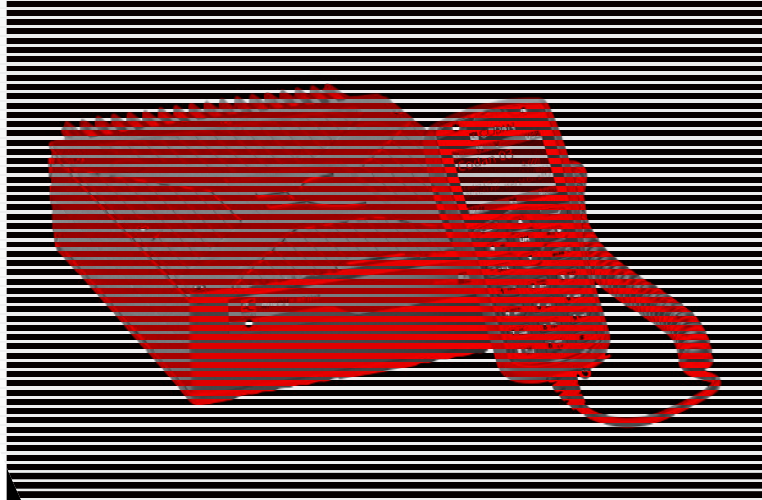

CODAN  
RADIO COMMUNICATIONS

RADIO COMMUNICATIONS

# Envoy™ Transceiver



Getting Started Guide

No part of this manual may be reproduced, transcribed, translated into any language or transmitted in any form whatsoever without the prior written consent of Codan Limited.

© Copyright 2012–2015 Codan Limited.

Codan part number 15-04177-EN Issue 5, January 2015.

CODAN™, Envoy™, Envoy™ SmartLink™, *Easitalk™*, CALM™, and TPS™ are trademarks of Codan Limited. Other brand, product, and company names mentioned in this document are trademarks or registered trademarks of their respective holders. The English version takes precedence over any translated versions.

---

# Table of contents

<b>Section 1</b>	<b>Introduction</b>	
	Overview of this guide . . . . .	1
	The 2220 Handset . . . . .	3
	The 2221 Handset . . . . .	5
	The 2230 Desk Console . . . . .	7
	Keypad . . . . .	8
	Standards and icons . . . . .	13
<b>Section 2</b>	<b>Using the wizard</b>	
	Overview of the wizard . . . . .	16
	Using the wizard . . . . .	18
	Selecting a language . . . . .	19
	Setting the time and date . . . . .	19
	Setting the types of connections between modules . . . . .	21
	Adding a channel . . . . .	21
	Entering a self address . . . . .	23
	Adding a contact . . . . .	24
	Selecting an antenna . . . . .	29
	Selecting a peripheral device . . . . .	30

---

<b>Section 3</b>	<b>Operating the transceiver</b>	
	Switching the transceiver on and off . . . . .	32
	Switching on the transceiver . . . . .	32
	Switching off the transceiver . . . . .	32
	The channel screen . . . . .	33
	Selecting a channel . . . . .	37
	Selecting a channel from a channel group . . . . .	38
	Scanning channels . . . . .	41
	Switching scanning on or off . . . . .	42
	Pausing scanning . . . . .	42
	Muting the transceiver . . . . .	44
	Switching mute on or off . . . . .	44
	Selecting the mute type . . . . .	45
	Using the microphone . . . . .	46
	Setting the basics . . . . .	47
	Setting the time and date . . . . .	47
	Setting the brightness of the display . . . . .	48
	Calling . . . . .	49
	Making a call to a contact . . . . .	50
	Making a call from the Call History . . . . .	51
	Making a call from the Emergency key . . . . .	53
	Making a Selective call . . . . .	54
	Making a Message call . . . . .	56
	Receiving a call . . . . .	60
	Viewing missed calls . . . . .	61
	Making a call when multiple control points are connected to the same RFU . . . . .	64
	Using digital voice . . . . .	66
	Overview of digital voice options . . . . .	66
	Switching the digital voice feature on or off . . . . .	69
	Selecting the digital voice rate . . . . .	72
	Selecting digital voice mute . . . . .	73
	Using GPS . . . . .	75
	Saving your current GPS position as a waypoint . . . . .	75
	Selecting a waypoint . . . . .	75
	Updating a waypoint from the Call History . . . . .	76
	Updating a waypoint from a contact . . . . .	77
	Adding a waypoint . . . . .	79
	Finding a waypoint . . . . .	81

---

Viewing the details of a waypoint . . . . .	82
Viewing GPS information . . . . .	82
Data options . . . . .	85
2.4 kbit/s Data Modem . . . . .	85
MIL/STANAG 2G Data . . . . .	91
RM50e HF Data Modem . . . . .	96
Using encryption . . . . .	100
Switching the secure feature on or off . . . . .	100
Selecting a secure key . . . . .	106
Changing the privacy code . . . . .	107
Adding a secure key . . . . .	108
Using a crosspatch . . . . .	111
Overview of the 3031 Crosspatch . . . . .	111
Changing the operating mode of the crosspatch . . . . .	113
Upgrading the transceiver via a USB stick . . . . .	114

## **Section 4      Contacts**

Adding a contact . . . . .	118
Adding a simple call . . . . .	119
Adding a Message call . . . . .	120
Adding a Phone call . . . . .	122
Completing the contact . . . . .	123
Adding a contact from the Call Log, Call History, or Last Heard Log . . . . .	125

## **Appendix A    Navigating the menu structure**

The basic menu structure . . . . .	128
Navigating the menu structure . . . . .	130
Overview of basic and advanced views . . . . .	132
Basic view . . . . .	132
Advanced view . . . . .	132
Switching between basic and advanced views . . . . .	133
Finding a word or value . . . . .	134
Selecting an icon . . . . .	137
Selecting a function from the menu bar . . . . .	138
Entering text in a field . . . . .	140
Entering a special character (2220/2230) . . . . .	143
Entering text with the 2221 Handset . . . . .	144
Selecting a value from a list . . . . .	146

---

Selecting/deselecting a check box . . . . .	147
Moving a slider . . . . .	148
Changing the order of items in a list . . . . .	149
Saving your changes . . . . .	150

## **Appendix B Structure of information**

Structure of user information . . . . .	152
Structure of contact and call information . . . . .	154

## **Appendix C Installing the transceiver**

Overview of mobile stations . . . . .	156
Cables in a mobile station . . . . .	157
Mounting a mobile Envoy™ station . . . . .	157
Connecting a mobile Envoy™ station . . . . .	159
Earthing the transceiver . . . . .	161
Earthing the antenna . . . . .	161
Overview of fixed stations . . . . .	162
Cables in a fixed station . . . . .	164
Mounting a fixed Envoy™ station . . . . .	164
Connecting a fixed Envoy™ station . . . . .	165
Earthing the transceiver . . . . .	167
Earthing the antenna . . . . .	167

## **Appendix D Specifications**

## **Appendix E Compliance**

Overview . . . . .	172
European R&TTE Directive . . . . .	172
Product marking and labelling . . . . .	172
Radiation safety (EU installations only) . . . . .	173
Declaration of Conformity and Notified Body Letter of Opinion . . . . .	173
Protection of the radio spectrum . . . . .	174
EMC and safety notices . . . . .	175
Radiation safety (non-EU installations) . . . . .	175
Sécurité des radiations (installations non-EU) . . . . .	176
EMC . . . . .	177
Electrical safety . . . . .	177

---

Earth symbols . . . . .	178
FCC compliance . . . . .	179
FCC Part 90 certification . . . . .	179
FCC Part 15 compliance . . . . .	179
IC certification . . . . .	180
Product markings and labelling . . . . .	180
RCM approval . . . . .	180

## Index

This page has been left blank intentionally.



---

# List of figures

Figure 1:	2220 Handset . . . . .	3
Figure 2:	2221 Handset . . . . .	5
Figure 3:	2230 Desk Console . . . . .	7
Figure 4:	Steps in the wizard . . . . .	17
Figure 5:	Wizard Startup screen . . . . .	18
Figure 6:	Channel screen . . . . .	34
Figure 7:	System lock and connected data application icons . . . . .	35
Figure 8:	Scanning screen . . . . .	36
Figure 9:	Chain call . . . . .	54
Figure 10:	Incoming call pop-up . . . . .	60
Figure 11:	Missed call pop-up for a single call . . . . .	62
Figure 12:	Missed call pop-up for multiple calls . . . . .	62
Figure 13:	Example of a missed call icon in the status bar of the channel screen . . . . .	62
Figure 14:	Calling information when multiple control points are connected . . . . .	65
Figure 15:	Channel screen showing the digital voice rate . . . . .	68
Figure 16:	Digital voice mute indicator . . . . .	69
Figure 17:	Channel screen showing on/off status for a DV option (without encryption) . . . . .	70
Figure 18:	Channel screen showing transmit/receive status for a DV option (without encryption) . . . . .	70
Figure 19:	Channel screen showing secure/clear status for all encrypted digital voice . . . . .	71
Figure 20:	Channel screen showing transmit/receive status for all encrypted digital voice . . . . .	71

---

Figure 21:	Envoy X2 Transceiver with 2.4 kbit/s Data Modem option and computer	86
Figure 22:	Envoy X2 Transceiver with MIL/STANAG 2G Data via serial cable	92
Figure 23:	Envoy X2 Transceiver with MIL/STANAG 2G Data via VCOM over USB cable	93
Figure 24:	Envoy X2 Transceiver with MIL/STANAG 2G Data via VCOM over Ethernet cable	94
Figure 25:	Transmit and receive screens during a MIL/STANAG 2G data call	96
Figure 26:	Envoy X2 Transceiver with RM50e HF Data Modem	97
Figure 27:	Transmit and receive screens during an RM50e data call	99
Figure 28:	Crosspatch status	112
Figure 29:	Call Log, Call History, and Last Heard Log	125
Figure 30:	Typical menu screen	128
Figure 31:	Menu structure (user level, basic view)	129
Figure 32:	Navigation indicator showing navigation keys that may be used	130
Figure 33:	Basic view (no advanced view indicator)	132
Figure 34:	Advanced view	133
Figure 35:	Find function	134
Figure 36:	Highlighted icon	137
Figure 37:	Functions on the menu bar	138
Figure 38:	Example of an editable text field	140
Figure 39:	Character-entry mode indicator	141
Figure 40:	List of entries, with and without focus	146
Figure 41:	Entry with a check box	147
Figure 42:	A slider value	148
Figure 43:	Screen that has changes to be saved	150
Figure 44:	Basic structure of information in the Envoy Transceiver	153
Figure 45:	Structure of call information for a contact in the Envoy Transceiver	154
Figure 46:	Typical mobile station	156
Figure 47:	Typical fixed station	163

---

# List of tables

Table 1:	Keys and their function . . . . .	8
Table 2:	Missed call icons that may be shown in the status bar of the channel screen . . . . .	63
Table 3:	Digital voice options . . . . .	66
Table 4:	Digital voice rates . . . . .	67
Table 5:	GPS information . . . . .	83
Table 6:	Status of the 2.4 kbit/s Data Modem . . . . .	88
Table 7:	Character-entry mode . . . . .	141
Table 8:	Cables for a typical mobile Envoy™ station . . . . .	157
Table 9:	Cables for a typical fixed Envoy™ station . . . . .	164
Table 10:	Specifications . . . . .	169
Table 11:	Earth symbols . . . . .	178

This page has been left blank intentionally.

---

# 1

# Introduction

Congratulations on choosing a Codan Envoy Transceiver to meet your HF communications needs. You can expect many years of reliable high performance, and if ever assistance is required, Codan's world-class after-sales support team is ready to help. Please read this guide thoroughly and retain it for future reference. There is an index at the end of this guide to assist you in finding information.

## Overview of this guide

This guide provides instructions on how to connect up your Envoy Transceiver, and how to perform basic setup and operating tasks. It assumes that you have limited knowledge of HF communication and of using an HF transceiver.

Extensive reference material is provided on the CD at the back of this guide.

**NOTE:** A range of options and accessories is available for the Envoy Transceiver. For more information contact your Codan representative or refer to the product catalogue that is applicable to your transceiver.

This guide contains the following sections:

[Introduction](#)—provides an overview of the components of the transceiver system

[Using the wizard](#)—describes the steps in the wizard that are used to set up the transceiver

[Operating the transceiver](#)—describes how to operate the transceiver and how to make calls

[Adding a contact](#)—describes how to add a contact

[Navigating the menu structure](#)—describes how to navigate the menu structure and perform basic selection and editing functions

[Structure of information](#)—describes the building blocks of information in the transceiver

[Installing the transceiver](#)—describes how to mount and connect the transceiver in mobile and fixed stations

[Specifications](#)—provides a list of specifications for the transceiver

[Compliance](#)—provides mandatory compliance information

# The 2220 Handset

The 2220 Handset is a control point for the Envoy Transceiver. The user interface provides an icon-based menu structure for easy setup and operation of the transceiver.

**Figure 1:** 2220 Handset

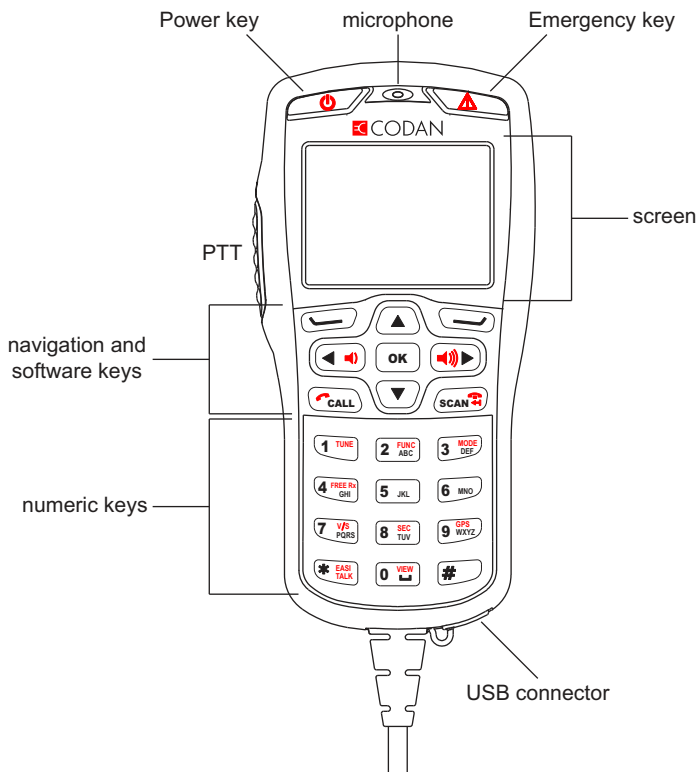

The 2220 Handset is a hand-held device that has a microphone, a PTT button, a screen, navigation keys, and numeric keys. The keypad enables you to control and configure the transceiver system via the user interface. The handset and an external speaker connect to the RFU via a special interface cable.

The 2220 Handset is shipped from the factory with standard functions pre-programmed to specific keys. The standard function is written on the key in **BLUE** text. New user-defined functions may be assigned to most of the keys.

**NOTE:** Handsets with a Mk 2 label on the rear escutcheon are compatible with all transceiver configurations, and are specifically designed to provide a received audio signal for an Envoy SmartLink. Mk 2 handsets are identified in **Information > Device Information > Hardware Options** as **Mk 2 (Envoy SmartLink enabled)**.

Related links:

[Keypad on page 8](#)

[Navigating the menu structure on page 127](#)



# The 2221 Handset



The 2221 Handset is a control point for the Envoy Transceiver. The user interface provides an icon-based menu structure for easy operation of the transceiver. It has a condensed set of keys for use in simpler communication scenarios.

**NOTE:** This handset is recommended for operating the transceiver only. Programming the transceiver should be completed via TPS System Programmer.

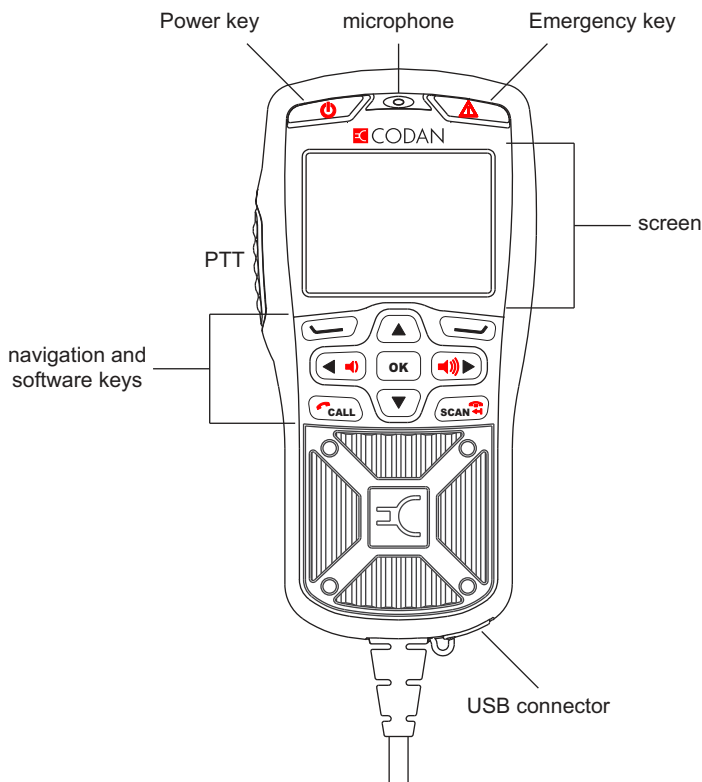
**Figure 2:** 2221 Handset



The 2221 Handset is a hand-held device that has a microphone, a PTT button, a screen, and navigation keys. The navigation keys enable you to operate the transceiver system via the user interface using pre-defined profile information. Typically, this profile is fully configured using the TPS System Programmer. The handset and an external speaker connect to the RFU via a special interface cable.

The 2221 Handset is shipped from the factory with specific functions pre-programmed on the  key, or in a general list that is accessed via the **Functions** icon (). New user-defined functions may be assigned to this general list.

**NOTE:** Handsets with a Mk 2 label on the rear escutcheon are compatible with all transceiver configurations, and are specifically designed to provide a received audio signal for an Envoy SmartLink. Mk 2 handsets are identified in **Information > Device Information > Hardware Options** as **Mk 2 (Envoy SmartLink enabled)**.

Related links:

[Keypad on page 8](#)

[Navigating the menu structure on page 127](#)

# The 2230 Desk Console

The 2230 Desk Console is a control point for the Envoy Transceiver. The user interface provides an icon-based menu structure for easy setup and operation of the transceiver. The desk console is standard for a fixed station.

**Figure 3:** 2230 Desk Console

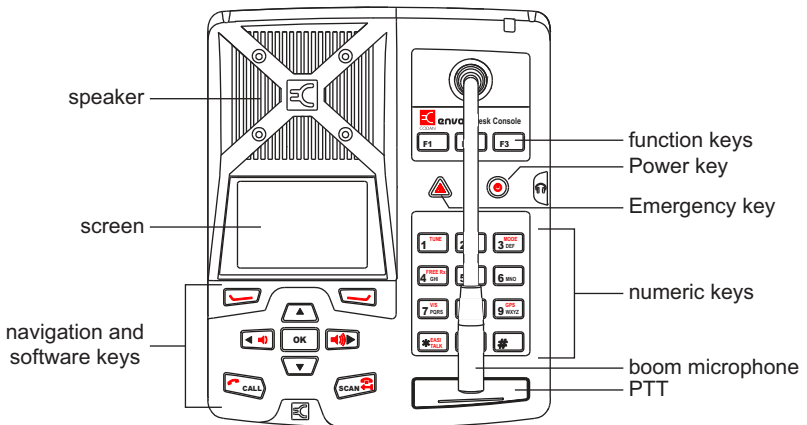

The 2230 Desk Console has an optional boom microphone, a built-in speaker, a PTT button, a screen, navigation keys, function keys, and numeric keys. The desk console also supports the use of headphones, a foot-switched PTT device, and a separate hand microphone with PTT. The keypad enables you to control and configure the transceiver system via the user interface.

The 2230 Desk Console is shipped from the factory with standard hot keys programmed to the numeric keys. The function that each standard hot key performs is written on the numeric key in **BLUE** text. New user-defined functions may be assigned to most of the keys.

Related links:

[Keypad on page 8](#)











[Navigating the menu structure on page 127](#)

# Keypad









Standard macros are programmed in the transceiver in the factory. You can also create a macro and assign it to a hot key.

NOTE: For more information, please see the Reference Manual.

**Table 1:** Keys and their function

Key	Function
	<p>Switches on the transceiver.</p> <p>Switches off the transceiver (<i>hold</i> for 2 sec).</p> <p>Performs a hot-key sequence with another key (<i>hold</i> + key):</p> <ul style="list-style-type: none"> <li>•  + 0 jumps to the Brightness screen</li> <li>•  + 2 toggles advanced view</li> <li>•  + 3 jumps to the Select Language screen (admin hidden)</li> <li>•  + <b>SEC</b> performs secure erase (if enabled)</li> <li>•  +  locks and/or erases important information in your transceiver if you need to abandon it (if enabled)</li> </ul>
	Starts a chain call of all of the calls included with the selected emergency contact ( <i>hold</i> for 2 sec).
PTT	<p>Press-to-talk.</p> <p>Cancels out of editing and calls before they are connected, returning directly to the channel/scanning screen.</p>
	Performs the function shown directly above the key in the menu bar of the screen.
	<p>Scrolls left in a list of values.</p> <p>Moves the cursor/highlight to the left.</p>

**Table 1:** Keys and their function (cont.)

Key	Function
	Reduces the volume when the  indicator is shown in the menu bar of the screen.
 	Scrolls right in a list of values. Moves the cursor/highlight to the right. Increases the volume when the  indicator is shown in the menu bar of the screen.
	Scrolls up in a list of entries. Moves the highlight up a row.
	Scrolls down in a list of entries. Moves the highlight down a row.
<b>OK</b>	Enters the submenu or list of entries represented by the selected icon/item. Toggles the selection of a check box. Enters the virtual keypad in character-entry mode of a 2221 Handset.
<b>CALL</b>	Starts the calling process by jumping to the call screen (default behaviour). Jumps to Contacts/Call History/Emergency Contacts/Last Heard Log ( <i>hold</i> for 2 sec, default behaviour).
<b>SCAN</b>  	Toggles scanning on and off. Ends a call. Deletes the character to the left of the cursor, one character at a time. Deletes all characters to the left of the cursor ( <i>hold</i> for 2 sec).

**Table 1:** Keys and their function (cont.)

<b>Key</b>	<b>Function</b>
<b>1</b>  <b>TUNE</b>	Enters 1 in character-entry mode.  Tunes the antenna.
<b>2</b>  <b>FUNC</b>	Enters 2, a, b, c, A, B, C in character-entry mode for English, or other characters as per the selected input language.  Accesses the clarifier for the currently selected channel.
<b>3</b>  <b>MODE</b>	Enters 3, d, e, f, D, E, F in character-entry mode for English, or other characters as per the selected input language.  Selects the next allowed mode for the current channel.
<b>4</b>  <b>FREE Rx</b>	Enters 4, g, h, i, G, H, I in character-entry mode for English, or other characters as per the selected input language.  Accesses the free-tune receive function. With some sales options, free-tune transmit may be available over specific frequency bands.
<b>5</b>	Enters 5, j, k, l, J, K, L in character-entry mode for English, or other characters as per the selected input language.  Toggles the operating mode of a crosspatch, if connected.
<b>6</b>	Enters 6, m, n, o, M, N, O in character-entry mode for English, or other characters as per the selected input language.

**Table 1:** Keys and their function (cont.)

Key	Function
<b>7</b>  <b>V/S</b>	Enters 7, p, q, r, s, P, Q, R, S in character-entry mode for English, or other characters as per the selected input language.  Toggles the type of mute selected.
<b>8</b>  <b>SEC</b>	Enters 8, t, u, v, T, U, V in character-entry mode for English, or other characters as per the selected input language.  Toggles secure/digital voice mode on and off.  Enables you to enter a PIN for a secure session, switch digital voice rates, or access secure information ( <i>hold</i> for 2 sec).
<b>9</b>  <b>GPS</b>	Enters 9, w, x, y, z, W, X, Y, Z in character-entry mode for English, or other characters as per the selected input language.  Opens the GPS screen, if the GPS Call option is installed.
<b>0</b>  <b>VIEW</b>	Enters a space (press) or 0 ( <i>hold</i> for 2 sec) in character-entry mode.  Toggles between the channel/scanning screen and Contacts/Call History/Last Heard Log.
<b>*</b>  <b>EASITALK</b>	Enters a special character in character-entry mode (repeated press, or <i>hold</i> for 2 sec to select from a list).  Toggles <i>Easitalk</i> on or off.



**Table 1:** Keys and their function (cont.)

<b>Key</b>	<b>Function</b>
#	Toggles character-entry mode.  Enables you to select the input language ( <i>hold</i> for 2 sec).  Toggles between a top-level channel group and the channels within.  Enables you to select a channel group ( <i>hold</i> for 2 sec).  Toggles between the Call History and the incoming/outgoing/missed call filters (2220/2230 only).
<b>F1 F2 F3</b> (2230 only)	Stores macros that may be used in any context.



# Standards and icons

The following standards and icons are used:

This typeface...	Means...
<i>Italic</i>	text requiring emphasis, or variable information
<b>Bold</b>	a key on a computer keyboard
<b>Bold</b>	a menu, submenu, tab, entry, a value in the user interface of the control point, or key that you press on the control point
	the user interface of the control point must be at admin level to perform the task
	the user interface of the control point must be in advanced view to perform the task
<b>NOTE:</b>	the text may be of interest to you
<b>CAUTION:</b>	proceed with caution as your actions may lead to loss of data, privacy or signal quality
<b>WARNING:</b>	your actions may cause harm to yourself or the equipment

This page has been left blank intentionally.

---

# 2

## Using the wizard

This section contains the following topics:

- *Overview of the wizard* on page 16
- *Using the wizard* on page 18
- *Selecting a language* on page 19
- *Setting the time and date* on page 19
- *Setting the types of connections between modules* on page 21
- *Adding a channel* on page 21
- *Entering a self address* on page 23
- *Adding a contact* on page 24
- *Selecting an antenna* on page 29
- *Selecting a peripheral device* on page 30

# Overview of the wizard

The wizard is available if the transceiver:

- has not been programmed with a profile
- has a basic profile that has the same self address for each of the default HF networks: Selcall and CALM
- has one scan table

The wizard steps you through setting up information in the transceiver so that it may be operated at a basic level.

**Figure 4:** Steps in the wizard



# Using the wizard

The wizard should start automatically when a new transceiver is powered up for the first time.

**Figure 5:** Wizard Startup screen





**NOTE:** If the wizard screen doesn't launch automatically, follow the instructions below. If your transceiver has been profiled using the TPS System Programmer, the wizard may not be available.

**NOTE:** For information on specific entries in the wizard, please see the Reference Manual.

To use the wizard:

- Press PTT, then press  (**Menu**) to return to the top level of the menu structure.







- Highlight the icon for the wizard (🧙), then press  (**OK**).  
If the icon is not visible, then the wizard is not available as the transceiver has been programmed already with a non-basic profile.
- Press  (**Yes**) to confirm that you want to start the wizard.  
If you want to bypass the wizard, press  (**No**).

## Selecting a language











**NOTE:** This step in the wizard is shown if you have multiple languages available.





















To select a language:

- Press  or  to scroll to the language that you want to use on the control point, then press **OK**.  
**NOTE:** The label above the  key appears in the selected language.
- Press  (**Save**) to save the information.

## Setting the time and date

To set the time and date:

- Press  or  to select the time zone that you want to use.
- Press  to move to the **Daylight Saving** entry.
- Press  or  to select the time that you want to use.
- Press  to move to the **Local Time** entry.
- Press  to enter edit mode for the local time.
- Press  or  to scroll to the value that you want to set, then press  to move to the next item.
- Repeat this for minutes, seconds and AM/PM values.

- Press  (**Save**) to save the local time.
  - Press  to move to the **Local Date** entry.
  - Press  to enter edit mode for the local date.
  - Press  or  to scroll to the value that you want to set, then press  to move to the next item.
  - Repeat this for the day/month and year, as required.
  - Press  (**Save**) to save the local date.
  - Press  to move to the **Clock** entry.
  - Press  or  to select the type of clock that you want to use.
  - Press  to move to the **Time Format** entry.
  - Press  or  to select the format that you want to use.
  - Press  to move to the **Date Format** entry.
  - Press  or  to select the format that you want to use.
  - If you want to review the information that you have entered, press  or  to move through the entries.
  - Press  (**Save**) to save the information.
- If you have not changed any of the time and date information, press  (**Close**).





## Setting the types of connections between modules

**NOTE:** This step in the wizard is shown if your control point is a desk console, or a Mk 2 handset connected via an Envoy SmartLink.

The types of cables used to connect the modules in your system affect whether or not the control point can power down and power up the RFU.

**NOTE:** For detailed connection diagrams, please see the Reference Manual.



To set the types of connections:

- Do *one* of the following:
  - If at least one connection between the control point and the RFU uses an Ethernet cable, press  (**Yes**), then continue from [Adding a channel on page 21](#).
  - If all connections between the control point and the RFU use Codan control cables, press  (**No**), then continue from [Adding a channel on page 21](#).





## Adding a channel

**NOTE:** This step in the wizard is shown if you are permitted to add channels.



To add a channel:



- Press  (**Yes**) to add a channel, if required.
- Enter the name that you want to use for the channel.
- Press  to move to the **Tx** entry.
- Enter the transmit frequency that you want to use for this channel (in kHz, with up to three decimal points or 1 Hz resolution).
- Press  to move to the **Rx** entry.

The **Rx** entry is automatically filled with the transmit frequency.

- Enter the receive frequency (in kHz, with up to three decimal points or 1 Hz resolution), if required to be different from the Tx frequency.
- Press ▼ to move to the **Mode** entry.
- To select a mode:
  - Press ► to view the list of available modes.
  - Press ▲ or ▼ to scroll to the mode that you want to use, then press **OK**.  
When the check box is selected, the item is enabled.  
When the check box is clear, the item is disabled.
  - Select other modes, as required.  
**NOTE:** The modes that you select become the allowed modes for this channel. In a scan table, you can duplicate a channel and select another of the allowed modes.
  - Press  (**Save**).
- If you want to review the information that you have entered, press ▲ or ▼ to move through the entries.
- Press  (**Save**) to save the information.
- Do *one* of the following:
  - If you want to add another channel, press  (**Yes**), then repeat these steps.
  - If you do not want to add another channel, press  (**No**).





The channels that you enter may be allocated to a scan table. A scan table enables you to manage how these channels are scanned using one set of properties.

- Do *one* of the following:
  - If you want to add a scan table, press  (**Yes**).
  - If you do not want to add a scan table, press  (**No**), then continue from *Entering a self address on page 23*.

- Do *one* of the following:
  - If you want to scan all of the channels in the transceiver that have a USB mode, press  (**Yes**), then continue from [Entering a self address on page 23](#).
  - If you want to choose the channels and modes that you want to scan, press  (**No**), then continue from [Adding channels to a scan table on page 23](#).

## Adding channels to a scan table

To add channels to a scan table:

- Press  or  to scroll to the channel that you want to add, then press **OK**.
- Press  or  to select the mode that you want to use.
- Select more channels, as required.
- Press  (**Save**) to add these channel selections.
- Continue from [Entering a self address on page 23](#).

## Entering a self address

A self address is used by other stations to call your station. For example, if the self address of your station is 1234, operators at other stations enter the address 1234 when they want to make a call to you.



To enter a self address:

- Enter the address that you want to use.
 

You can enter up to six digits, or you may leave the self address blank if a peripheral device has its own self address set.

**NOTE:** Addresses ending in one or more 9 or 0 digits have a special function in Selcall HF networks.
- Press  (**Save**) to save the information.

**NOTE:** The wizard automatically allocates this self address to the default HF networks: Selcall and CALM (if FED-STD-1045 ALE or MIL-STD-188-141B ALE option is installed).

- Do *one* of the following:
  - If you want to add a contact, press  (**Yes**), then continue from [Adding a contact on page 24](#).
  - If you do not want to add a contact, press  (**No**), then continue from [Selecting an antenna on page 29](#).

## Adding a contact

A contact is a person or organisation that you want to call, and for which you want to pre-define the method of calling. You may be able to contact the same person or organisation via a number of different methods. When you set up the contact, you define each method as a separate call for the contact.

To add a contact:

- Enter the name that you want to use for the contact, then press  (**Add Call**).

The **HF Network** entry is highlighted.

The HF network defines the call system and self address that is used by your station when the call is made.

- Press ◀ or ▶ to select the HF network that you want to use.
- Press ▼ to move to the **Call Type** entry.
- Press ◀ or ▶ to select the call type that you want to use.

**NOTE:** The call type that you select affects information that you can enter for the remainder of this call.

- If you are adding:
  - a Selective, Channel Test, Emergency, Get Position or Send Position call, continue from [Adding a simple call on page 25](#)
  - a Message call, continue from [Adding a Message call on page 26](#)
  - a Phone call, continue from [Adding a Phone call on page 28](#)

Related links:

[Contacts on page 117](#)

## Adding a simple call

A simple call is a call that requires an address only at this stage of the definition process.

To continue with adding a Selective, Channel Test, Emergency, Get Position or Send Position call:

- Press ▼ to move to the **Selcall/ALE Address** entry.

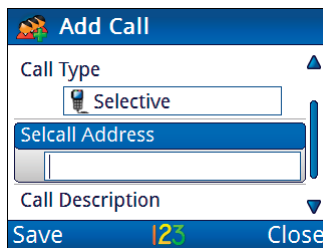

- Enter the address of the station that you want to call.
- Continue from [Completing the contact on page 28](#).





## Adding a Message call

To continue with adding a Message call:

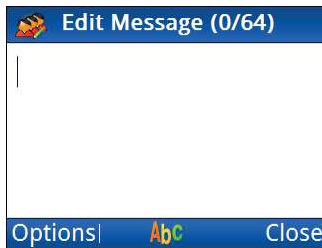

- Press ▼ to move to the **Selcall|ALE Address** entry.
- Enter the address of the station that you want to call.
- Press ▼ to move to the **Message** entry, then press ►.

**NOTE:** If you want to be prompted to enter a message at the time of the call, leave the value for the **Message** entry as **<Empty>**.



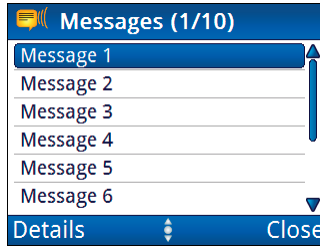

- If you want to enter a message:
  - *Hold #* to select a different input language, if required.
  - Start typing the message.  
**NOTE:** Press **OK** to start a new line, if required.
  - Press  (**Options**), scroll to **Save**, then press  (**Select**) to add the message to the call.
- If you want to select a message from a list of stored messages:
  - Press  (**Options**), scroll to **Stored**, then press  (**Select**).

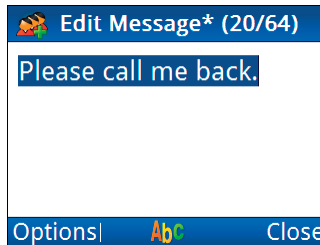

- Press ▲ or ▼ to scroll to the message that you want to use.
- NOTE: If you want to view the message, press  (**Details**) to view the message, then press  (**Close**).
- Press **OK** to select the message.
  - Edit the message, if required.



- Press  (**Options**), scroll to **Save**, then press  (**Select**).
- Continue from *Completing the contact* on page 28.







## Adding a Phone call

To continue with adding a Phone call:

- Press ▼ to move to the **Phone Number** entry.
- Enter the phone number.
- Continue from *Completing the contact on page 28*.

## Completing the contact

To finish entering the information required for the contact:

- Press ▼ to move to the **Call Description** entry.  
The call type is entered automatically as the call description.
- Enter a new description for this call, if required.
- Press  (**Save**) to save the information.
- If you want to add another call for the contact, press  (**Yes**), then repeat the steps for adding a call.  
If you do not want to add another call, press  (**No**).
- If you want to add another contact, press  (**Yes**), then repeat the steps for adding a contact.  
If you do not want to add another contact, press  (**No**).
- Do *one* of the following:
  - If you want to select an antenna, continue from *Selecting an antenna on page 29*.
  - If you do not want to select an antenna, press  (**Close**), then continue from *Selecting a peripheral device on page 30*.





---

## Selecting an antenna

Each type of antenna has a specific requirement for tuning, and the transceiver uses a different protocol for each one. You must select the type of antenna that is used in your station so that the transceiver knows how to tune the antenna. Some antennas, such as broadband antennas, do not require tuning.

To select an antenna:

- Press ▲ or ▼ to scroll to the antenna type that you want to use, then press **OK**.
- Press  (**Save**) to save the information.
- Do *one* of the following:
  - If you want to connect an accessory to the 15-way connector of the RFU, press  (**Yes**), then continue from [Selecting a peripheral device on page 30](#).
  - If you do not want to connect an accessory, press  (**No**), then press **OK** to close the wizard.

## Selecting a peripheral device

When you select the peripheral device from the list, the transceiver automatically sets these properties. The default settings should be adequate for most situations, however, if you have special requirements, please see the Reference Manual for more detailed information.

**NOTE:** Codan peripheral devices are listed by their type number, for example, 3031 Crosspatch. The type number for a Codan device is located on the front or serial number escutcheon.

To select a peripheral device:

- Press ▲ or ▼ to scroll to the type of peripheral device that is attached to the connector, then press **OK**.

If there are settings that you can change to customise this peripheral for your requirements, ► is shown to the right of the peripheral name when it is selected.

- If you want to change settings for the peripheral, press ► to see the list of entries that you may change.

If the value of an entry for a peripheral device has been changed from the default value, ● is shown next to the title of the entry.

- Press  (**Save**) to automatically update settings for correct operation of the connected peripheral device.
- Press **OK** to close the wizard.
- If you added a peripheral device, restart your transceiver to activate the new settings.

---

# 3

# Operating the transceiver

This section contains the following topics:

- *Switching the transceiver on and off* on page 32
- *The channel screen* on page 33
- *Selecting a channel* on page 37
- *Selecting a channel from a channel group* on page 38
- *Scanning channels* on page 41
- *Muting the transceiver* on page 44
- *Using the microphone* on page 46
- *Setting the basics* on page 47
- *Calling* on page 49
- *Using digital voice* on page 66
- *Using GPS* on page 75
- *Data options* on page 85
- *Using encryption* on page 100
- *Using a crosspatch* on page 111
- *Upgrading the transceiver via a USB stick* on page 114

# Switching the transceiver on and off

## Switching on the transceiver

To switch on the transceiver:



- Press .

The template screen, then the welcome screen (if set) are shown briefly, followed by the channel screen.

## Switching off the transceiver

The power-down function controls which modules are switched off. In some instances, it may only be the control point that switches off and the RFU remains powered. The default behaviour is for both the control point and the RFU to switch off.

To switch off the transceiver:

- Do *one* of the following:
  - Hold  for 2 sec, then release.
  - Press , then press **OK**.

The transceiver is switched off.

**NOTE:** For more information on the power-down function, see the Reference Manual.

---

# The channel screen

The channel screen shows the following information:

- the name of the currently selected channel  
NOTE: If ... is shown before the channel name, then this channel is contained within a channel group.
- the transmit and receive frequencies, if applicable
- the status areas that show specific information about the transceiver
- a bar graph that indicates the signal strength on receive (green) and the output power on transmit (red)
- the transmit power level setting
- the call type icon (when calling) or the scan indicator (when scanning, see [Figure 8](#))
- the mute type indicator
- a missed call icon, if applicable
- the mode
- the crosspatch indicator, if connected
- the clarifier indicator, if set
- calling and system locks when the RFU is being used by a connected data application or another control point (see [Figure 7](#))

**Figure 6:** Channel screen

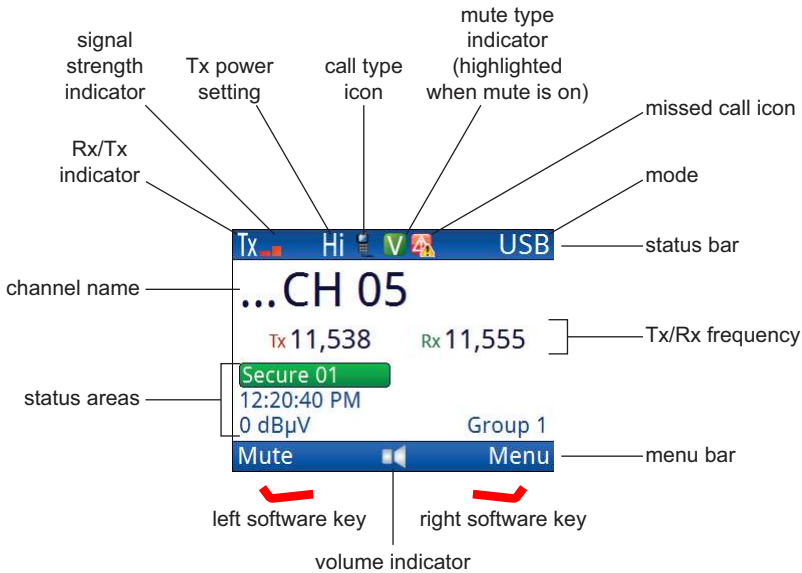

**NOTE:** If you cannot transmit on the channel, **Inhibit** is shown as the Tx frequency.

If the transmit and receive frequencies are the same, the frequency is only shown on the right side of the screen. The Rx/Tx indicator shows whether the transceiver is receiving (green) or transmitting (red). The more bars that are shown, the higher the signal strength.

The status area of the screen provides six separate areas in which you can show information that is relevant for your operations. Your system administrator can choose the information that is shown in each status area. If encryptor/scrambler options are enabled, this information is shown in the top line of the status area (status areas 1 and 2). Any selections that have been made are discarded.

**NOTE:** For information on how to set up what is shown in the status areas, please see the Reference Manual.

Your transceiver may have the option of selecting high, medium, or low power, as set in **Settings > Configuration > Tx Power**. By default, you can toggle between the Tx power settings by pressing the **6** key. **Hi**, **Med**, or **Lo** is shown respectively to the right of the signal strength indicator. If an external power amplifier is connected, **PA** may also be selected.

While a call is being established, the transceiver shows that calling activity is in progress by flashing  in place of the scan indicator. Once a call is established, these indicators are replaced with an icon that represents the type of call being sent or received.

**NOTE:** For detailed information on call types, please see the Reference Manual.

**Figure 7:** System lock and connected data application icons

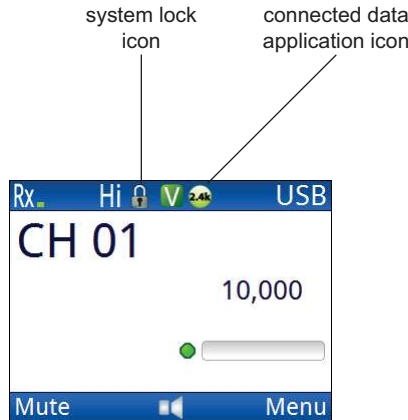

When the transceiver is scanning, the channel screen is replaced by the scanning screen.

**Figure 8:** Scanning screen

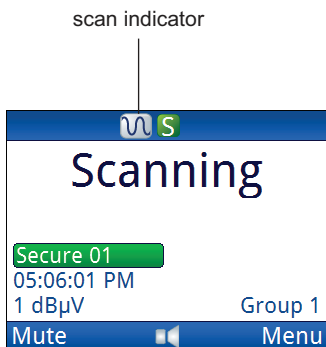



# Selecting a channel

To select a channel:

- Press PTT to exit to the channel or scanning screen.
- If the transceiver is scanning, press **SCAN** to switch off scanning.

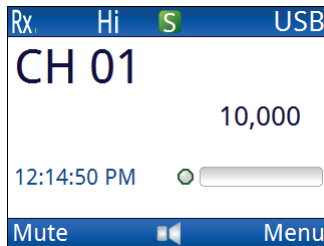

- Press ▲ or ▼ to scroll to the channel that you want to use.

The channel is selected.

**NOTE:** If you want to change the sideband, press **MODE**.  
If the mode does not change, there is only one mode for the channel.

**NOTE:** If you have an automatic antenna tuner fitted, press PTT to tune the antenna to the currently selected channel.

- Do any of the following:
  - Hold **OK** to edit the channel, if permitted.
  - Press **OK** to search for a channel.
  - Press **CALL** to start a call.
  - Hold **CALL** to go to Contacts.

# Selecting a channel from a channel group

If channel grouping is enabled in **Settings > Control Point > Channel Grouping** and you have allocated channels to groups, indicated by ... after a channel group name or in front of the channel name, you may have to switch to another channel group to find the channel that you want to select.

**NOTE:** Any channels that are not assigned to a channel group appear at the top level with the channel group names. These channels are selected by scrolling to the channel.

**NOTE:** You can set the name of the current channel group to show in a status area of the channel screen.

To select a channel from a channel group:

- Press PTT to exit to the channel or scanning screen.
- If the transceiver is scanning, press **SCAN** to switch off scanning.

Channel group level  
and ungrouped channels

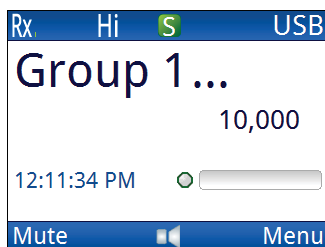

Channel level (within a group)

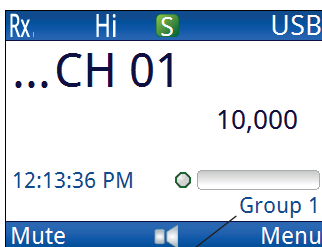

channel group name

- If you are at the channel group level, which may include ungrouped channels, press **▲** or **▼** to scroll to the channel group that you want, then press **#** to view the channels within that group.

- If you are within a channel group but the channel that you want is not visible, do *one* of the following:
  - Press **#** to move to the channel group level, press **▲** or **▼** to scroll to the channel group that you want, then press **#**.



- *Hold #* to see a list of channel groups, press **▲** or **▼** to scroll to the channel group that you want, then press **✓** (**Select**).



- Press **▲** or **▼** to scroll to the channel that you want to use.  
The channel is selected.

**NOTE:** If you want to change the sideband, press **MODE**.  
If the mode does not change, there is only one mode for the channel.

**NOTE:** If you have an automatic antenna tuner fitted, press PTT to tune the antenna to the currently selected channel.

- Do any of the following:
  - *Hold* **OK** to edit the channel, if permitted.
  - Press **OK** to search for a channel.
  - Press **CALL** to start a call.
  - *Hold* **CALL** to go to Contacts.

---

# Scanning channels

If you intend to receive calls on several channels, switch on scanning. When scanning is switched on, the transceiver sequentially selects each channel/mode in your scan tables to detect incoming calls. The channels are scanned in a continuous cycle. By default, mute is switched on automatically when scanning is switched on.

**NOTE:** Only those scan tables that are set to be scanned have the channels scanned. Up to 100 channels may be scanned.

By default, when the transceiver detects a call addressed to your station, it stops scanning and notifies you according to the type of call received. When you press  to end the call, scanning resumes. If you do not press this key to end the call, or any other key within a pre-determined timeout, the transceiver automatically ends the call and resumes scanning.

**NOTE:** The default standby state for the transceiver is to return to scanning so that it is ready to receive calls across a range of frequencies.

When the transceiver detects a signal, it notifies you according to the mute setting selected. If your transceiver is set to notify you when voice is detected (**V**), you can pause scanning, select the channel/mode on which the voice was heard, then resume scanning when required. Voice mute also detects calls that are addressed to any station on the scanned frequency, and any other channel disturbances. If your transceiver is set to selcall mute (**S**), it only pauses scanning when it detects a call addressed to your station, regardless of the call system used.

Your choice of voice or selcall mute depends on whether or not you have to detect voice signals, and how much noise and traffic you want to hear.

It is recommended that scanning is switched on when you are not using the transceiver to communicate so that you are able to receive calls on any frequency in the scanned scan tables.

## Switching scanning on or off

To switch scanning on or off:

- Press **SCAN**.

If a call is not in progress, scanning is toggled on or off.

If a call is in progress, the call is ended and the transceiver begins scanning.

If a call from a modem (or any other peripheral device) is in progress, you are prompted to break the system lock to resume scanning.

**NOTE:** When scanning is switched on, mute is also switched on.

**NOTE:** If you press PTT while the transceiver is scanning, the scan is stopped.

## Pausing scanning

To pause scanning:

- Do *one* of the following:
  - To pause scanning on the last-selected channel, press **OK**.
  - To pause scanning and scroll to another channel, press **▲** or **▼**.

The channel/modes through which you can scroll are those in the scan tables that are being scanned. They are not listed alphabetically but in the order in which they are being scanned.

If you do not press a key within 30 sec, the transceiver automatically resumes scanning, by default.

- While scanning is paused, do *one* of the following:
  - To speak on the selected channel, *hold down* PTT.
  - To resume scanning immediately, press **OK**.
  - To stop scanning completely, press **SCAN**.





# Muting the transceiver

When the transceiver is set to a channel or is scanning channels, and mute is switched off, you hear on-air signals on each channel. If you do not want to listen to this, you can silence the transceiver by switching on mute.

You can set the mute to switch off when a voice signal or any other calling activity is detected (voice mute **V**), or only when a call addressed to your station is received (selcall mute **S**). Your choice of voice or selcall mute depends on whether or not you have to detect voice signals, and how much noise and traffic you want to hear. When digital voice is active and scanning is switched off or paused, you can also set the mute to switch off only when a secure or clear digital voice signal is detected (digital voice mute **D**). The voice signal is output to the speaker connected to the RFU or desk console speaker.

## Switching mute on or off

To switch mute on or off:





- If you are using a 2220 Handset or 2230 Desk Console, press  (**Mute**) on the channel screen, scanning screen, or free-tune screen.
- If you are using a 2221 Handset:
  - Press  (**Options**).
  - Press  or  to scroll to the **Mute On|Off** option.
  - Press  (**Select**).

The **V** or **S** in the status bar of the channel screen is highlighted when mute is on.





## Selecting the mute type

To select the mute type:

- If you are using a 2220 Handset or 2230 Desk Console, press **V/S** to toggle the mute type between selcall mute (**S**) and voice mute (**V**).
- If you are using a 2221 Handset:
  - Press  (**Options**).
  - Press  or  to scroll to the **V/S** option.
  - Press  (**Select**).

**NOTE:** When digital voice is active and scanning is switched off or paused, an additional digital voice mute (**D**) is available.

# Using the microphone

The microphone on the handset is located at the top between the  and  keys. When you talk into the microphone:

- hold the microphone side-on and close to your mouth
- *hold down* PTT
- speak clearly at your normal volume and rate
- release PTT to return to receiving mode

On the desk console, you can speak directly into the boom microphone.

**NOTE:** By default, the transceiver is set up to transmit a short beep when you release PTT. This removes the need for you to say ‘over’ at the end of your transmission.

**CAUTION:** Your conversation can be monitored by anyone tuned to your transmit frequency, unless you are using one of Codan’s encryptors. Your signal can potentially travel very large distances.

If PTT is held continuously for a certain length of time, the system stops transmission, switches to receive and shows an error message on the control point. This ensures that, even if the PTT button is being held down accidentally, the battery will not be flattened, and your transceiver is ready to receive calls.

You can set the length of time the system waits before it cuts transmission (default is 10 min), or switch off this feature.























---

# Setting the basics

## Setting the time and date

The transceiver is set to UTC time in the factory. You set the local time and time zone for the location of the control point. This feature is useful if you have a communication network that spreads over several time zones, or you need to time stamp your transmissions according to the current time at longitude zero.



To set the time and date:

- From the main menu, select  (**General**), then  (**Time and Date**).
- Press  (**Set**).
- Press  to move to the **Time Zone** entry.
- Press  or  to select the time zone that you want to use.
- Press  to move to the **Daylight Saving** entry.
- Press  or  to select the time that you want to use.
- Press  to move to the **Local Time** entry.
- Press  to enter edit mode for the local time.
- Press  or  to scroll to the value that you want to set, then press  to move to the next item.
- Repeat this for minutes, seconds and AM/PM values.
- Press  (**Save**) to save the local time.
- Press  to move to the **Local Date** entry.
- Press  to enter edit mode for the local date.
- Press  or  to scroll to the value that you want to set, then press  to move to the next item.
- Repeat this for the day/month and year, as required.
- Press  (**Save**) to save the local date.
- Press  to move to the **Clock** entry.

- Press ◀ or ▶ to select the type of clock that you want to use.
- Press ▼ to move to the **Time Format** entry.
- Press ◀ or ▶ to select the format that you want to use.
- Press ▼ to move to the **Date Format** entry.
- Press ◀ or ▶ to select the format that you want to use.
- If you want to review the information that you have entered, press ▲ or ▼ to move through the entries.
- Press  (**Save**) to save the information.

## Setting the brightness of the display

To set the brightness:

- Do *one* of the following:
  - Press  + 0.
  - From the main menu, select  (**General**), then  (**Brightness**).

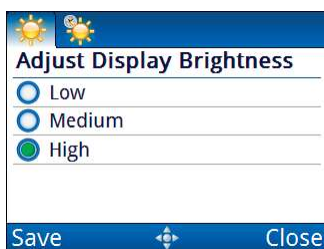

- Press ▲ or ▼ to scroll to the value that you want to set, then press **OK**.
- Press  (**Save**) to save the information.

---

# Calling

This section describes how to make the various types of calls from the transceiver. You can make a call to a contact, return or repeat a call from the Call History, or enter information at the time of the call.

For selective calling in ALE/CALM and Selcall HF networks, a control point must register a self address from the list of available addresses for that HF network. Self addresses are included in the HF network information in either the **Selcall|ALE Self Address** or **Additional Self Addresses** entries. If you select an HF network for a call that does not have a registered self address for the control point, you will be prompted to register one of the available self addresses. If you decline to register at this prompt, you can register a self address in **General > Register Self Address** (available in advanced view if the HF network has two or more self addresses).

**CAUTION:** Your control point should have a registered self address for each HF network in which you want to receive non-data calls. If a 3031 Crosspatch is connected as a peripheral device to the 15-way connector and you want to be able to receive calls that are specifically addressed to the crosspatch, its self address must be entered in the **Settings > Connectors > RFU 15way > RFU 15way Startup** entry, for example **selfid 3031**

**NOTE:** Depending on the options installed in your transceiver, additional call types from those discussed in this guide may be available. For more information, please see the Reference Manual.

**NOTE:** Depending on the setup of the HF network used for the call and the digital voice and/or encryption options installed in the transceiver, the transceiver may switch automatically between analogue/digital voice and/or clear/secure signals.

Related links:

[Overview of digital voice options on page 66](#)

## Making a call to a contact

**NOTE:** The default behaviour for the **CALL** key is to press it to start a call, or *hold CALL* to see your Contacts/Call History. This behaviour may be reversed by your system administrator, if required.

To make a call to a contact:

- *Hold CALL.*
- Press ▲ or ▼ to scroll to the contact who you want to call.

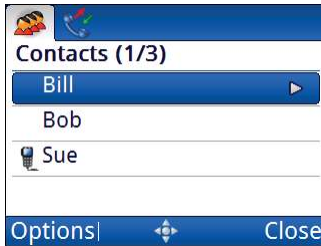

If there is more than one call available for the contact,  is shown to the right of the contact name when it is highlighted. If there is only one call for the contact, the icon for this call is shown to the left of the contact name.

- If multiple calls are available, press **CALL** or .

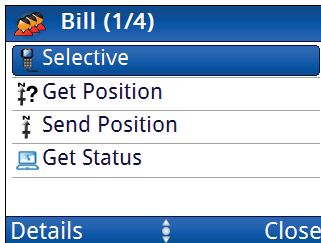

- Press ▲ or ▼ to scroll to the call that you want to make.  
The call types that are available for the contact are set up in **User Data > Contacts**.  
**NOTE:** If only one call has been set up for the contact, you cannot change this at the time of the call.
- Press **CALL**.  
**NOTE:** Depending upon the call type and other information stored with the contact, you may be prompted to select information during the call. Press **CALL** to progress through these prompts.
- If prompted, press ▲ or ▼ to scroll to the channel that you want to use, then press **CALL**.  
A  is shown next to the currently selected channel/mode.  
To abort the call before it is answered, press PTT or **SCAN**.  
There will be audible beeps or a pop-up message to indicate that the call has been successful.  
**NOTE:** If **Settings > Calling > General > LBT Mode** is set to **Enabled** or **Override allowed**, you may be asked to make the call again if the channel is occupied.

## Making a call from the Call History

The Envoy Transceiver stores information for up to 200 calls that have been sent and received for a control point. Each control point may store this call information for up to 20 RFUs to which it has been connected. The detailed Call History is accessed by *holding CALL*, then pressing ► to scroll to the **Call History** tab.

**NOTE:** For more information on the Call History, please see the Reference Manual.

**NOTE:** The default behaviour for the **CALL** key is to press it to start a call, or *hold CALL* to see your Contacts/Call History. This behaviour may be reversed by your system administrator, if required.

**NOTE:** A filtered Call Log is available in the call screen. This log contains only the latest instance of a call to and from a specific station, and provides records of up to 20 calls.

**NOTE:** Missed calls are indicated by an exclamation mark in a yellow triangle in front of the call icon.

To make a call from the Call History:

- *Hold* **CALL**.
- Press ◀ or ▶ to select the **Call History** tab.

The unfiltered history of the last 200 calls is shown.

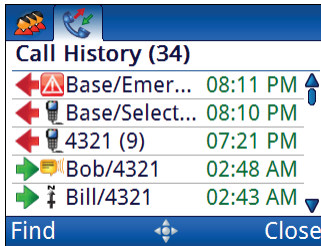

**NOTE:** If you want to view two lines of information for each call as you scroll through the Call History, switch to advanced view (⏻ + 2).

- If you want to filter the Call History by incoming calls, outgoing calls, or missed calls, press # repeatedly until the log that you want to view is shown (2220/2230 only).
- Press ▲ or ▼ to scroll to the call that you want to return or repeat.

**NOTE:** You can also press **Find**, enter appropriate characters, then highlight the call that you want to return or repeat.

- If you want to view the details of the call, press **Options**, scroll to **Details**, then press **Select**.

Press **Close** to exit from the call details.



- Press ◀ or ▶ to select the call type that you want to use.
- Continue from making your chosen call type.

Related links:

[Viewing missed calls on page 61](#)



## Making a call from the Emergency key

You can set up an emergency contact with calls that are chained together when you *hold* the  key. Emergency contacts are set up in **User Data > Contacts > Emergency Contacts**.

**CAUTION:** If you have more than one emergency contact, you will be prompted to select the emergency contact who you want to call at the time of the call.

**NOTE:** For more information, please see the Reference Manual.

To make a call from the Emergency key:

- *Hold*  for 2 sec.
- If you have more than one emergency contact, scroll to the contact who you want to call, then press **CALL**.
- If prompted, press  or  to scroll to the channel that you want to use, then press **CALL**.

A  is shown next to the currently selected channel/mode.

To abort the call before it is answered, press PTT or **SCAN**.

There will be audible beeps or a pop-up message to indicate that the call has been successful.

**NOTE:** Calls made from the  key always override LBT mode if it is enabled.

**NOTE:** If there are several calls programmed for this emergency contact, the transceiver proceeds with the next call following a pre-defined pause.

**Figure 9:** Chain call

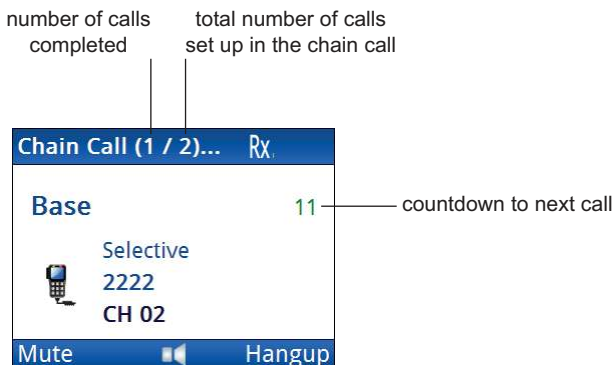

## Making a Selective call

If you want to speak with the operator at a particular station, make a Selective call to the address of that station. When the station receives the call, the transceiver sounds an alert tone to notify the operator.









To make a Selective call:

- Press **CALL**.

**NOTE:** You may be prompted to register a self address on this control point for the HF network that you are using to make the call.

The call type and address of the last call are shown at the top of the call screen. The filtered Call Log below this shows the latest instance of any call type made to or received from a particular address.



- If you do not want to use the HF network shown at the top right of the screen:
    - Press  (**Options**).
    - Scroll to **HF Networks**, then press  (**Select**).
    - Scroll to the HF network that you want to use, then press **OK**.
  
  - Press  or  to select the Selective call type if it is not selected.
- NOTE:** If you want to test the quality of the channel before you make the actual call, *hold CALL* first.
- Do *one* of the following:
    - To repeat the call to the last address used, press **CALL**.
    - To call a different station, enter the address, then press **CALL**.
    - To repeat or return a call from the Call Log, press  to scroll to the call, press  or  to select your required call type, then press **CALL**.
    - To use an ALE address syntax in an ALE/CALM HF network, press  (**View**), scroll to **ALE**, press  (**Select**), scroll to the syntax that you want to use, then press **CALL**.

- If prompted, press ▲ or ▼ to scroll to the channel that you want to use, then press **CALL**.

A  is shown next to the currently selected channel/mode.

To abort the call before it is answered, press PTT or **SCAN**.

There will be audible beeps or a pop-up message to indicate that the call has been successful.

**NOTE:** If **Settings > Calling > General > LBT Mode** is set to **Enabled** or **Override allowed**, you may be asked to make the call again if the channel is occupied.

## Making a Message call

If you want to send a text message to another station, make a Message call.

You can:

- enter a message at the time that you make a call
- store up to 10 messages in **User Data > Messages** for later use
- store messages in a contact as part of a pre-programmed Message call

To make a Message call:

- Press **CALL**.

**NOTE:** You may be prompted to register a self address on this control point for the HF network that you are using to make the call.

The call type and address of the last call are shown at the top of the call screen. The filtered Call Log below this shows the latest instance of any call type made to or received from a particular address.

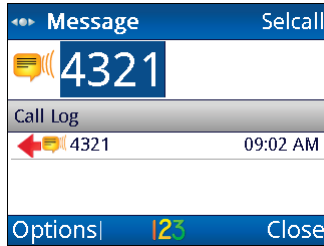



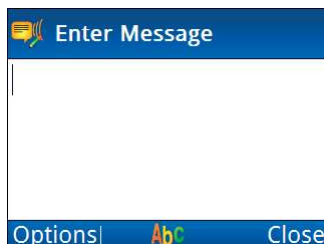

- If you do not want to use the HF network shown at the top right of the screen:
  - Press (**Options**).
  - Scroll to **HF Networks**, then press (**Select**).
  - Scroll to the HF network that you want to use, then press **OK**.
- Press or to select the Message call type if it is not selected.
- Do *one* of the following:
  - To repeat the call to the last address used, press **CALL**.
  - To call a different station, enter the address, then press **CALL**.
  - To repeat or return a call from the Call Log, press to scroll to the call, press or to select your required call type, then press **CALL**.
  - To use an ALE address syntax in an ALE/CALM HF network, press (**View**), scroll to **ALE**, press (**Select**), scroll to the syntax that you want to use, then press **CALL**.







- If you want to enter a message:
  - *Hold #* to select a different input language, if required.
  - Start typing the message.

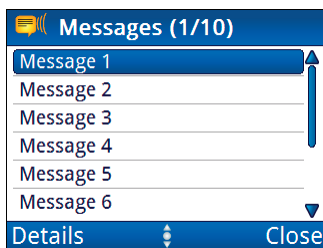



NOTE: Press **OK** to start a new line, if required.

  - Press  (**Options**), scroll to **OK**, then press  (**Select**) to add the message to the call.
  
- If you want to select a message from a list of stored messages:
  - Press  (**Options**), scroll to **Stored**, then press  (**Select**).

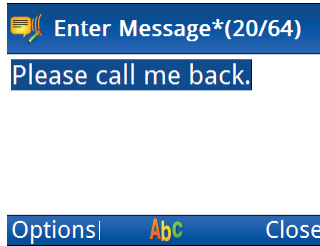

- Press  or  to scroll to the message that you want to use.
- NOTE: If you want to view the message, press  (**Details**) to view the message, then press  (**Close**).
- Press **OK** to select the message.
  - Edit the message, if required.



- Press  (**Options**), scroll to **OK**, then press  (**Select**).
- If prompted, press  or  to scroll to the channel that you want to use, then press **CALL**.

A  is shown next to the currently selected channel/mode.

To abort the call before it is answered, press PTT or **SCAN**.

There will be audible beeps or a pop-up message to indicate that the call has been successful.

**NOTE:** If **Settings > Calling > General > LBT Mode** is set to **Enabled** or **Override allowed**, you may be asked to make the call again if the channel is occupied.

**Related links:**

[Entering text in a field on page 140](#)

[Entering text with the 2221 Handset on page 144](#)

## Receiving a call

Some calls that are addressed to your station are handled automatically by your transceiver. It will either respond automatically with the information requested in the call that it received (Get Position, Get Status, Channel Test, or ALE Sounding call), or receive the message (Message or Send Position call). The remaining call types (Selective, Phone, and Emergency) sound an alarm at your station.

For incoming ALL, ANY, Group Selective, and Wildcard calls to multiple control points, any control point that has a matching address will receive the call, if permitted. You may have to switch off mute and change the mute type to be able to hear the conversation.

Selective and Phone calls sound an alarm that is similar to a telephone ringing. An Emergency call sounds a hee-haw alarm.

To answer an incoming call:

- Listen for an incoming call tone.

An incoming call pop-up shows information on the type of call, the address of the caller, the time of the call, and the channel used.

**Figure 10:** Incoming call pop-up



After the period set in **Settings > Calling > General > In Call Timeout** has lapsed in the transceiver, the incoming call pop-up changes to the missed call pop-up.



---

**NOTE:** Depending on the setup of the HF network used for the call and the digital voice and/or encryption options installed in the transceiver, the transceiver may switch automatically between analogue/digital voice and/or clear/secure signals.

- If you are receiving a Selective or Emergency call, answer the call by *holding* PTT and speaking side-on across the microphone in the handset, or directly into the microphone on the desk console.
- If you are receiving a Phone call, press PTT to accept the call, then release PTT.

An automatic voice message is played that asks you to wait while the connection is made. Do not speak during this time.

## Viewing missed calls

If you do not answer a call on your transceiver, a missed call pop-up is shown on the channel screen. The icon for the call type is shown with an exclamation mark. You can scroll through the missed call pop-up to acknowledge the missed calls. If the missed call pop-up is closed without acknowledging a missed call, a missed call icon for the call is shown in the status bar of the channel screen. If the missed call pop-up contains a short message that may be viewed fully in the pop-up, a missed call icon is not shown for this message in the status bar when you close the pop-up.

A list of the possible missed call icons in the status bar is provided in [Table 2](#). The details of any missed call may be viewed in the pop-up, or via the Call History or Call Log.

**NOTE:** The incoming call pop-up changes to a missed call pop-up when the sending station hangs up the voice-type call, or when the period set in **Settings > Calling > General > In Call Timeout** has lapsed.

**Figure 11:** Missed call pop-up for a single call

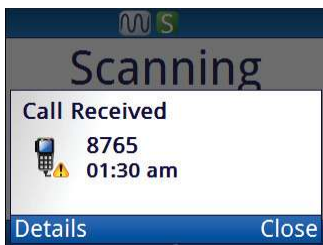

**Figure 12:** Missed call pop-up for multiple calls





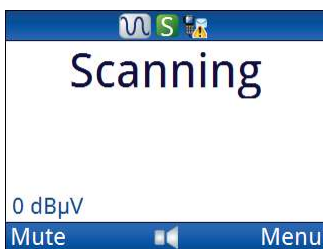

**Figure 13:** Example of a missed call icon in the status bar of the channel screen



**NOTE:** Received Get Status and Get Position calls, which do not present an incoming call pop-up, are not tracked as missed calls.

**Table 2:** Missed call icons that may be shown in the status bar of the channel screen

Icon	Description
	At least one missed or unread Emergency call exists (takes priority over all other missed calls)
	At least one missed Selective, Phone, ALL, ANY, Group Selective or Wildcard call exists (voice-type call)
	At least one unread Message or Send Position call exists ( <i>received</i> message-type call)
	At least one missed voice-type call <i>and</i> one unread message-type call exists

To view the details of a missed call:

- Do *one* of the following:
  - In the missed call pop-up, press ▲ or ▼ to scroll to the missed call that you want to view.
  - Press **CALL**, then press ▲ or ▼ to scroll to the missed call that you want to view in the Call Log.
  - **Hold CALL**, press ► to select 🌐 (**Call History**), press # repeatedly until the Call History is filtered as **Missed Calls**, then press ▲ or ▼ to scroll to the missed call that you want to view.
- Press 🔴 (**Details**).



- Press ▼ to scroll through the details of the missed call.
- Press  (Close).
- If you want to return a missed call, scroll to the call, press **CALL**, then continue with the call.

## Making a call when multiple control points are connected to the same RFU

When multiple control points are connected to the same RFU and a call is made, certain activities may be excluded if the control point does not have control of the call. If two or more control points have the same self address registered for use in the HF network, and one of these stations makes a call, then any control points with the same self address also have control of the outgoing call. PTT is on a first-come, first-served basis, and all other control points are not able to PTT while the RFU is in the transmit state. Control points that have a different self address registered may be able override calling and system locks.

**NOTE:** For more information on registering a self address for your control point, see the Reference Manual.

Control points that have control of a call show the same calling information. Control points that do not have control of the call show a **System busy** pop-up if an attempt to interrupt or join the call is made. You may have to switch off mute and change the mute type to be able to hear the conversation.

**Figure 14:** Calling information when multiple control points are connected



You may be able to override this lock, depending on the value set in **Settings > Calling > General > Calling Lock Override**.

To override a call lock, if permitted:





- Press **CALL**, **SCAN**, **PTT**, or attempt to change the channel or mode, then confirm any prompts to abort the call or to override a system lock.

# Using digital voice

## Overview of digital voice options

Digital voice is now offered through two distinct methods. The latest method offers digital voice with or without MIL/STANAG 2G Data, and with or without an AES-256 Encryption upgrade; these are referred to as the DV options with/without an AES-256 Encryption upgrade. The earlier method offers AES-encrypted digital voice only, and is referred to as the AES-256 DV Encryptor. Stations must have the same digital voice method activated for successful communication.

**Table 3:** Digital voice options

Sales option	Encryptor type	Tab Icon	When the digital voice option is inactive...	When the digital voice option is active...
DV (15-10591)	—		Analogue voice	Digital voice
DV (15-10591) Upgrade, AES-256 Encryption (15-10595)	AES-256		Analogue voice	Secure digital voice
MIL/STANAG 2G Data + DV (15-10590)	—		Analogue voice Clear data	Digital voice Clear data
MIL/STANAG 2G Data + DV (15-10590) Upgrade, AES-256 Encryption (15-10595)	AES-256		Analogue voice Clear data	Secure digital voice Secure data

**Table 3:** Digital voice options (cont.)

Sales option	Encryptor type	Tab Icon	When the digital voice option is inactive...	When the digital voice option is active...
AES-256 DV Encryptor (15-10565)	AES-256		Analogue voice	Secure digital voice

Related links:

[Using encryption on page 100](#)

### Digital voice rate

The digital voice rate sets the speed with which digital voice transmissions are sent. The digital voice rate is shown in status area 1 of the screen. Use the lowest digital voice rate in the first instance, then if good HF propagation conditions exist, a higher rate may be selected.

**NOTE:** Receiving DV stations, which have both MELPe and TWELP vocoders available by default, automatically switch to the appropriate rate and vocoder type when a signal is detected.

**Table 4:** Digital voice rates

Digital voice option	Vocoder type	Available voice rates (bit/s)
DV	MELPe	1 200, 2 400
DV with AES-256 Encryption upgrade MIL/STANAG 2G Data + DV MIL/STANAG 2G Data + DV with AES-256 Encryption upgrade	TWELP	600, 1 200, 2 400
AES-256 DV Encryptor	–	1 200, 2 400

**NOTE:** The 600 bit/s and 1200 bit/s rates are available as sales options for the DV options (with or without encryption). The AES-256 DV Encryptor has standard data rates of 1200 bit/s and 2400 bit/s.

**Figure 15:** Channel screen showing the digital voice rate

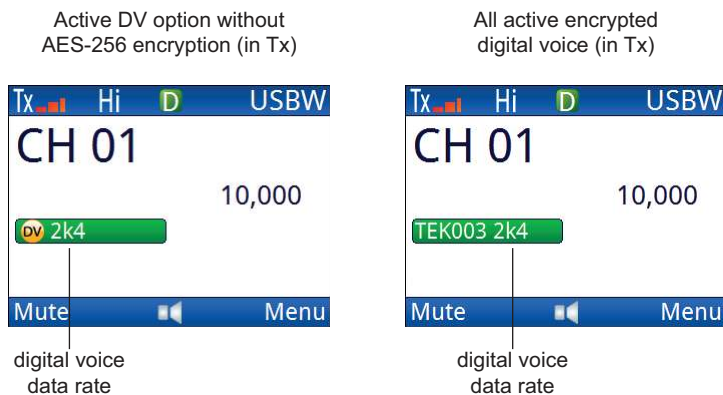

Related links:

[Selecting the digital voice rate on page 72](#)

[Overview of digital voice options on page 66](#)

## Digital voice mute

When any digital voice is active, you have the option of selecting voice mute (**V**), selcall mute (**S**), or digital voice mute (**D**). Digital voice mute enables only secure digital voice or clear digital voice to be processed through to the user when scanning is switched off or paused. Voice mute enables all clear and secure voice detected at your station to be heard by the user, and selcall mute blocks all signals except for calls specifically addressed to your station.



**Figure 16:** Digital voice mute indicator

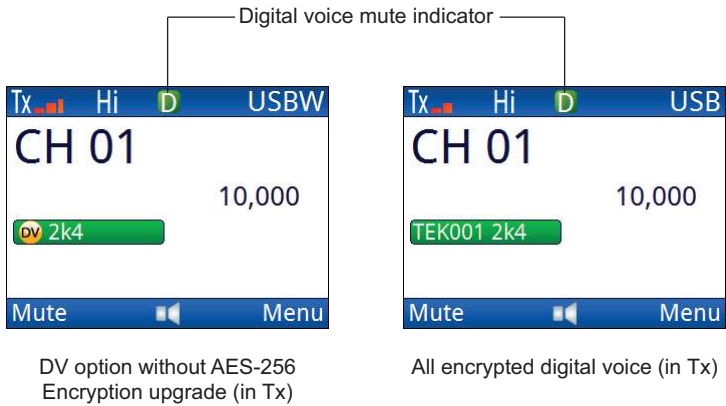

Related links:

[Selecting digital voice mute on page 73](#)

## Switching the digital voice feature on or off

To switch the digital voice feature on or off:

- If you are using a 2220 Handset or 2230 Desk Console, press **SEC**.
- If you are using a 2221 Handset:
  - Press **Options**.
  - Press **▲** or **▼** to scroll to the **Secure On|Secure Off** option.
  - Press **Select**.

Digital voice is toggled on or off.

**Figure 17:** Channel screen showing on/off status for a DV option (without encryption)

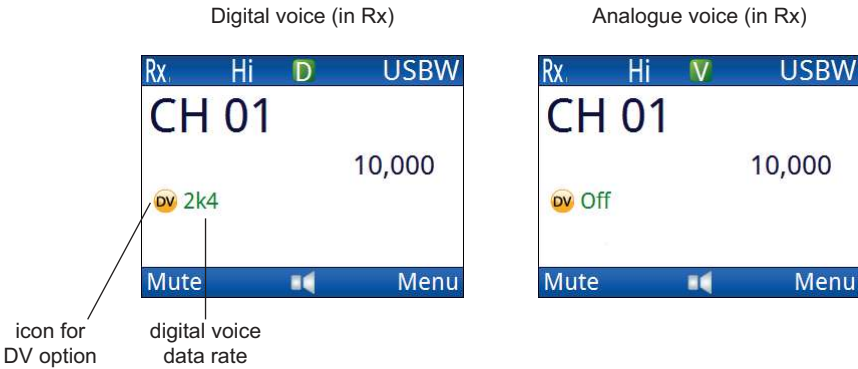

**Figure 18:** Channel screen showing transmit/receive status for a DV option (without encryption)

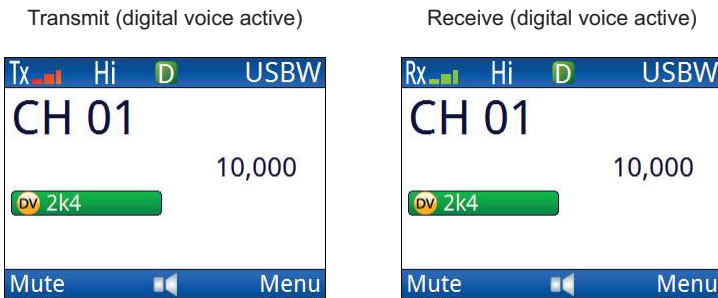

**CAUTION:** If RC50-C is active in a data link and you enable voice mode or press PTT, wait for up to 25 sec before continuing with the digital voice transmission. The receiving station needs this time to regain digital voice synchronisation.

**NOTE:** When transmitting via a DV option, listen for the Tx ready beep after you have released PTT before you *hold* PTT again.

**CAUTION:** When transmitting with the AES-256 DV Encryptor, you should *hold* PTT, wait 2 sec, speak, wait 2 sec, then release PTT.

If you have a DV option with the AES-256 Encryption upgrade installed, or you have the AES-256 DV Encryptor installed, the transceiver will also go secure/clear when **SEC** is pressed.

**Figure 19:** Channel screen showing secure/clear status for all encrypted digital voice

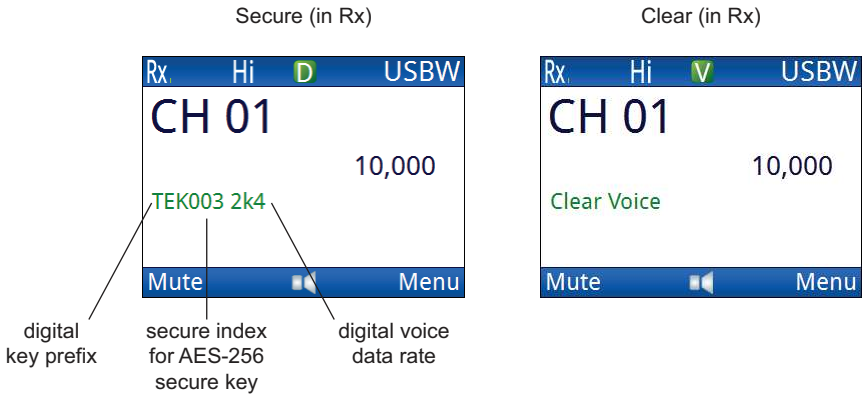

**Figure 20:** Channel screen showing transmit/receive status for all encrypted digital voice

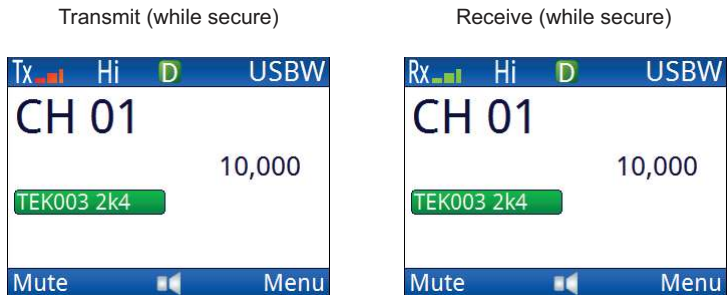







## Selecting the digital voice rate

The digital voice rate sets the speed with which digital voice transmissions are sent. The digital voice rate is shown in status area 1 of the screen. Use the lowest digital voice rate in the first instance, then if good HF propagation conditions exist, a higher rate may be selected. The rates from which you can select depend on the vocoder options that you have installed.

**NOTE:** Receiving DV stations, which have both MELPe and TWELP vocoders available by default, automatically switch to the appropriate rate and vocoder type when a signal is detected.

**NOTE:** If you change the digital voice rate frequently, you should consider assigning the **Next Digital Voice Rate** macro from **Unassigned** to a hot key. For detailed information on editing a macro, please see the Reference Manual.

To select a different digital voice rate:

- If you are using a 2220 Handset or 2230 Desk Console, do *one* of the following:
  - From the main menu, select  (**General**), then  (**Secure**).
  - Hold **SEC**.
- If you are using a 2221 Handset:
  - From the main menu, select  (**Functions**).
  - Press  or  to scroll to the **Secure Info** function.
  - Press  (**Select**).

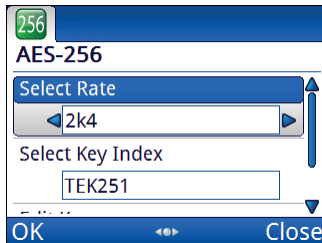

- Press ◀ or ▶ to select the digital voice rate that you want to use.
- Press  (OK).

Related links:





[Digital voice rate on page 67](#)

## Selecting digital voice mute

**NOTE:** Digital voice mute is available when a DV option (with or without the AES-256 Encryption upgrade) or the AES-256 DV Encryptor is active, and scanning is switched off or paused.

**NOTE:** If you want to suppress any noise burst on a connected or built-in loudspeaker during an operational event (for example, changing a channel or mode) select the **Muted unless digital voice** check box in **Settings > Security > Digital Voice Options**.

To select digital voice mute:

- Switch off scanning.
- If you are using a 2220 Handset or 2230 Desk Console, press **SEC**, then press **V/S** until **D** is shown in the centre of the status bar on the channel screen.
- If you are using a 2221 Handset:
  - Press  (**Options**).
  - Press ▲ or ▼ to scroll to the **Secure On** option.
  - Press  (**Select**).
  - Press  (**Options**).
  - Press ▲ or ▼ to scroll to the **V/S/D** option.
  - Press  (**Select**).
  - Repeat these steps until **D** is shown in the centre of the status bar on the channel screen.

DV option without AES-256  
Encryption upgrade (in Tx)



All encrypted digital voice (in Tx)



Related links:





[\*Digital voice mute on page 68\*](#)

---

# Using GPS









## Saving your current GPS position as a waypoint

To save your current GPS position as a waypoint:

- Do *one* of the following:
  - Press **9|GPS**.
  - From the main menu, select  (**General**), then  (**GPS**).
- Press  (**Save**).
- Enter the name that you want to use for the waypoint.
- Press  (**Options**), scroll to **Save**, then press  (**Select**) to save the waypoint.

## Selecting a waypoint

To select a waypoint:

- Do *one* of the following:
  - Press **9|GPS**.
  - From the main menu, select  (**General**), then  (**GPS**).
- Press  to move to the **Distance and Bearing** tab.
- Press  (**Waypoint**).
- Press  or  to select the **Waypoint** tab.
- Press  to move to the waypoint that you want to set.
- Press  (**Options**), scroll to **Set**, then press  (**Select**).

## Updating a waypoint from the Call History

You can update a waypoint using information from a Get Position call or a received Send Position call in the Call History. If you do not want to use the waypoint information immediately, you may save it.

Waypoints that are saved via the **Distance and Bearing** tab are automatically added to the **Waypoints** tab at the same location, and to the list of waypoints in **User Data > Waypoints**.

To update a waypoint from the Call History:





- Do *one* of the following:
  - Press **9|GPS**.
  - From the main menu, select **General**, then **GPS**.
- Press **▶** to move to the **Distance and Bearing** tab.
- Press **↵** (**Waypoint**), then press **◀** or **▶** to select the **Call History** tab.

The information available is filtered on Get Position calls that you have sent and Send Position calls that you have received.



- Press **▲** or **▼** to scroll to the call containing the GPS information that you want to use for the waypoint.
- If you want to set the GPS information as the current waypoint, press **↵** (**Options**), scroll to **Set**, then press **↵** (**Select**).









- If you want to save the GPS information as a waypoint:
  - Press  (**Options**), scroll to **Save**, then press  (**Select**).
  - Enter the name that you want to use for the waypoint.  
NOTE: If required, you can change the GPS information.
  - Press  (**Options**), scroll to **Save**, then press  (**Select**).
- Press  (**Close**).

## Updating a waypoint from a contact

You can update a waypoint using information gathered from a Get Position call for a contact.

To update a waypoint from a contact:

- Do *one* of the following:
  - Press **9|GPS**.
  - From the main menu, select  (**General**), then  (**GPS**).
- Press  to move to the **Distance and Bearing** tab.
- Press  (**Waypoint**), then press  or  to select the **Contacts** tab.

The information available is filtered on Get Position calls to contacts that have been set up in **User Data > Contacts**.

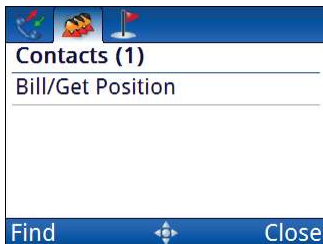

- Press ▲ or ▼ to scroll to the contact whose GPS information you want to use for the waypoint.
- Press **Options**, scroll to **Call**, then press **Select**.

If prompted, select a channel, then press **OK**.

The GPS information appears in an incoming call pop-up.



- Press **OK**.

The waypoint information is updated, and the source of the GPS information is shown at the top of the screen.

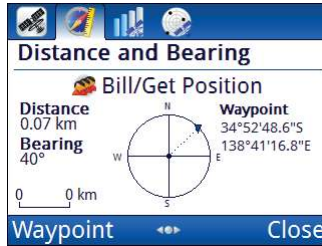







- Press  (**Close**).





## Adding a waypoint

You can create a waypoint by entering GPS information and providing it with a meaningful name. The waypoint can be saved for future use.

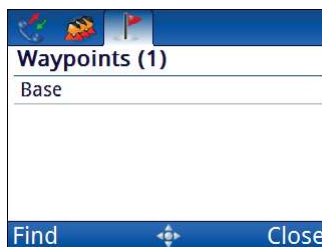
To add a waypoint:







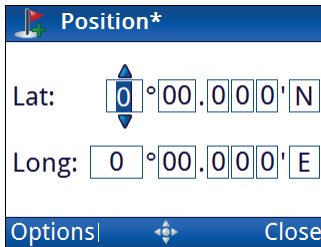



- Do *one* of the following:
  - Press **9|GPS**.
  - From the main menu, select  (**General**), then  (**GPS**).
- Press  to move to the **Distance and Bearing** tab.
- Press  (**Waypoint**), then press  or  to select the **Waypoints** tab.



- Do *one* of the following:
  - If there are no waypoints programmed in the transceiver, press  (**Add**).
  - If there are some existing waypoints programmed in the transceiver, scroll to the waypoint after which you want to add the new waypoint, press  (**Options**), scroll to **Add**, then press  (**Select**).
- Enter the name that you want to use for the waypoint.
- Press  to move to the **Position** entry, then press .



**NOTE:** The format of the GPS information is set in **Settings > GPS > GPS Format Options**.

- Do *one* of the following:
  - To use your current location, press  (**Options**), scroll to **Use GPS**, then press  (**Select**).
  - To enter a new location, press  or  to scroll to the value or use the numeric keys to enter the value that you want to set, then press  to move to the next field.
- Press  (**Options**), scroll to **Save**, then press  (**Select**) to save the GPS information.
- Press  (**Options**), scroll to **Save**, then press  (**Select**) to save the waypoint.
- Press  (**Close**).

The waypoint information is updated, and the source of the GPS information is shown at the top of the screen.

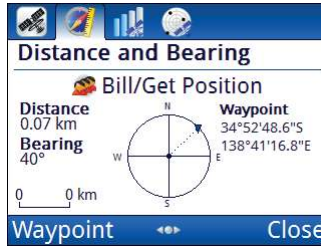











## Finding a waypoint

To find a waypoint:

- Do *one* of the following:
  - Press **9|GPS**.
  - From the main menu, select **General**, then **GPS**.
- Press **▶** to move to the **Distance and Bearing** tab.
- Press **Waypoint**.
- Press **◀** or **▶** to select the tab in which you want to search.
- Press **Find**.
- Enter the letter or number on which you want to search.  
Any entries or values that contain the character you have entered are shown in a list, with the character highlighted.
- Enter more characters to refine your search.
- Press **▲** or **▼** to scroll to the waypoint, then press **OK** to select it.

## Viewing the details of a waypoint



To view the details of a waypoint:

- Do *one* of the following:
  - Press **9|GPS**.
  - From the main menu, select  (**General**), then  (**GPS**).
- Press  to move to the **Distance and Bearing** tab.
- Press  (**Waypoint**).
- Press  or  to select the **Call History**, **Contacts** or **Waypoints** tab.
- Press  or  to scroll to the waypoint that you want to view.  
The call details, call information, or waypoint position is shown respectively.
- Press  (**Options**), scroll to **Details**, then press  (**Select**).

## Viewing GPS information

**NOTE:** You can view GPS information if the GPS Call option is installed. GPS information may be provided via a connected GPS receiver that is selected as a peripheral device or data entered into **Settings > GPS > My Position**.

To view GPS information:



- Do *one* of the following:
  - Press **9|GPS**.
  - From the main menu, select  (**General**), then  (**GPS**).
- Press  to move to the tab that you want to view.

**NOTE:** The **Signal Strength** and **Satellites Constellation** tabs are available only when a GPS receiver is used to provide the GPS information.

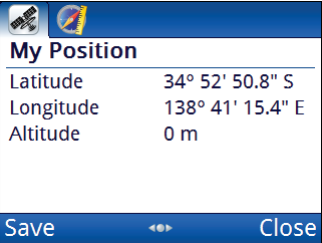
**Table 5:** GPS information

Tab	Description
	<p>Shows the latitude and longitude readings from a GPS receiver, or from <b>Settings &gt; GPS &gt; My Position</b>. Altitude and speed readings are hidden by default. The spinning circle shows that the GPS receiver is active, and the Last Fix reading shows the time lapse from the last receipt of valid GPS information.</p>
	<p>Shows the distance and bearing from your location to a selected waypoint.</p>

**Table 5:** GPS information (cont.)

Tab	Description
	<p>Shows the signal strength from each visible satellite. The number represents a particular satellite, and its location is shown on the <b>Satellites Constellation</b> tab. Satellites with a blue signal strength provide information for the GPS location.</p>
	<p>Shows a map of visible satellites. The satellites that are coloured blue provide the strongest signals and this information is used to establish the position of the receiver. The other satellites are visible, but the signal is weaker and the information is ignored.</p>

- Press  (Close).



---

# Data options

## 2.4 kbit/s Data Modem

**NOTE:** The 2.4 kbit/s Data Modem option must be enabled in your Envoy X2 Transceiver.

This internal data modem provides an extremely robust, field-proven HF waveform that is interoperable with Codan's proprietary 3012 protocol and 3212 HF Data Modem (operating in compatibility mode).

**NOTE:** When a data application is connected, an icon appears in the status bar of the channel screen ()

This modem can be used with ALE and Selcall call systems. Voice links may be established first, then a data exchange may be performed.

The modem is controlled by the connected computer using the UUPlus© HF data applications. Email is sent and received via your chosen email client, for example Microsoft® Office Outlook®. For information on using UUPlus©, please see the documentation provided with the product.

### Typical 2.4 kbit/s data station

A typical data station comprises:

- an Envoy X2 Transceiver with the 2.4 kbit/s Data Modem option enabled (Codan part number 15-10559)
- a suitable 12 V DC power supply
- an antenna system
- a PC running UUPlus© or suitable terminal program
- appropriate connecting cables

**NOTE:** Software that operates on standard telephone modems should operate over HF via the AT commands.

**Figure 21:** Envoy X2 Transceiver with 2.4 kbit/s Data Modem option and computer

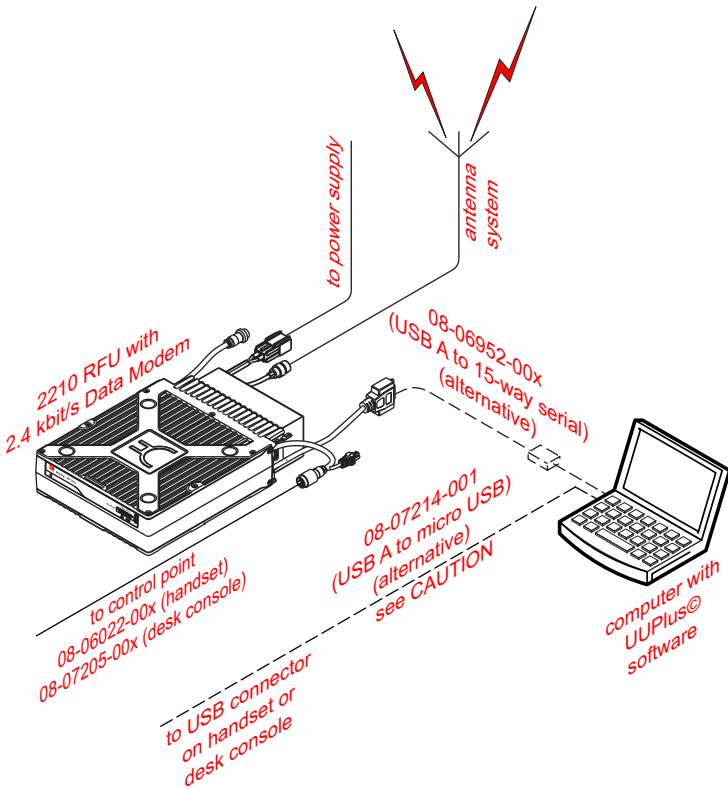

**CAUTION:** If VCOM is used over a USB–USB connection between the Envoy Transceiver with the internal data modem interface and the computer running the UUPlus application, the **2.4 kbit/s Modem Interface** peripheral device must not be selected on the 15-way port.

**CAUTION:** The USB–USB connection may be used with 2220/2221 Handsets and 2230 Desk Consoles in stations that are not exposed to excessive local HF interference.

**CAUTION:** Data transmitted via a VCOM session over a USB–USB connection may be affected by your computer’s power-saving activities. Either disable the power-saving mode while data is being transmitted, or verify that the data has been sent correctly when the computer wakes from power-saving mode.

**NOTE:** For information on setting up the data station, please see the Reference Manual.

## Using the 2.4 kbit/s data station

### Making a data call

Data calls are made in the background when you send an email via UUPlus© (or similar), or when transferring a file between terminal sessions.

**NOTE:** For information on sending an email via UUPlus©, please see the documentation provided with the software.

To make a data call:

- Compose your email in UUPlus© (or similar).
- Do *one* of the following:
  - If you want to make the call using a specific channel, switch off scanning on the transceiver’s control point, then scroll to the channel that you want to use for the call.
  - If you want to make the call using an ALE/CALM HF network, switch on scanning on the transceiver’s control point.

**NOTE:** If a channel is common to both HF networks, the type of HF network used for the call is determined by the scanning status when the call is made.

- In UUPlus©, press **Send**.

**NOTE:** If you are already in an existing Selcall or ALE/CALM link, you will be asked to confirm if you want to override the lock on the system from the existing link.

## Viewing the performance of the 2.4 kbit/s Data Modem

You can set one of the status areas to show the link status and throughput of the internal data modem.

To view the performance of the modem:

- Go to the channel screen.
- Use the information in [Table 6](#) to determine the status of the 2.4 kbit/s Data Modem.

**Table 6:** Status of the 2.4 kbit/s Data Modem

Colour of LED	State	Description
Green	Solid	<p>The transceiver has the modem enabled as a peripheral device on the 15-way port.</p> <p>The modem is enabled and a computer is communicating with it via VCOM over the USB–USB connection.</p>  <p>The screenshot shows a blue header bar with 'Rx', 'Hi', a green LED icon with '2.4k', and 'USB'. Below this, 'CH 01' is displayed in large white text. To the right, '10,000' is shown above a green signal strength indicator. At the bottom, there is a blue bar with 'Mute' and a speaker icon, and 'Menu' on the right.</p>

**Table 6:** Status of the 2.4 kbit/s Data Modem (cont.)

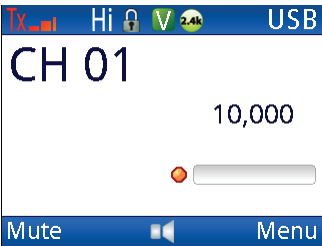
Colour of LED	State	Description
Green	Flashing	<p>The station is establishing a link, or in a link, with another station. This station is the receiver of the link.</p>  <p>The screenshot shows a blue-themed display. At the top, it reads 'Rx' (Receiver), 'Hi' (High Power), a lock icon, a green battery icon, a '2.4K' speed indicator, and 'USB'. The main display area shows 'CH 01' in large white text. Below that, the number '10,000' is displayed. A green progress bar is shown, with a green dot at the beginning. At the bottom, there are 'Mute' and 'Menu' buttons with a speaker icon.</p>
Red	Flashing	<p>The station is establishing a link, or in a link, with another station. This station is the initiator of the link.</p>  <p>The screenshot shows a blue-themed display. At the top, it reads 'Tx' (Transmitter), 'Hi' (High Power), a lock icon, a green battery icon, a '2.4K' speed indicator, and 'USB'. The main display area shows 'CH 01' in large white text. Below that, the number '10,000' is displayed. A red progress bar is shown, with a red dot at the beginning. At the bottom, there are 'Mute' and 'Menu' buttons with a speaker icon.</p>

**Table 6:** Status of the 2.4 kbit/s Data Modem (cont.)

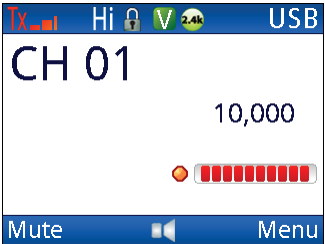
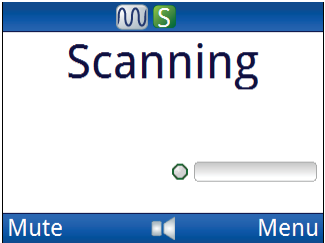
Colour of LED	State	Description
Red (bar)	Variable length	<p>Red bar is indicative of the data throughput rate for the link.</p> 
Grey	Solid	<p>The modem is enabled in the firmware, but a computer is not connected and/or not communicating with it.</p>  <p>Check that VCOM is running as a background task.</p>

**CAUTION:** Data transmitted via a VCOM session over a USB–USB connection may be affected by your computer’s power-saving activities. Either disable the power-saving mode while data is being transmitted, or verify that the data has been sent correctly when the computer wakes from power-saving mode.

---

## MIL/STANAG 2G Data

MIL/STANAG 2G Data provides data communications. It may also be used to provide high-grade AES-256 digital encryption. It must be used in conjunction with the RC50-C HF Email software. The data modem is capable of high-speed data transfer at speeds of up to 9600 bit/s using STANAG 4539 waveforms. This modem also supports MIL-STD-188-110A/B (including Appendix F), STANAG 4285, STANAG 4529, and STANAG 4415 waveforms.

**NOTE:** When a data application is connected, an icon appears in the status bar of the channel screen (.

Related links:

[Using encryption on page 100](#)

### Typical MIL/STANAG 2G data station

A typical MIL/STANAG 2G data station comprises:

- an Envoy X2 Transceiver with MIL/STANAG 2G Data option
- an antenna system
- an appropriate 12 V DC power supply
- a computer with RC50-C HF Email software
- appropriate connecting cables

**Figure 22:** Envoy X2 Transceiver with MIL/STANAG 2G Data via serial cable

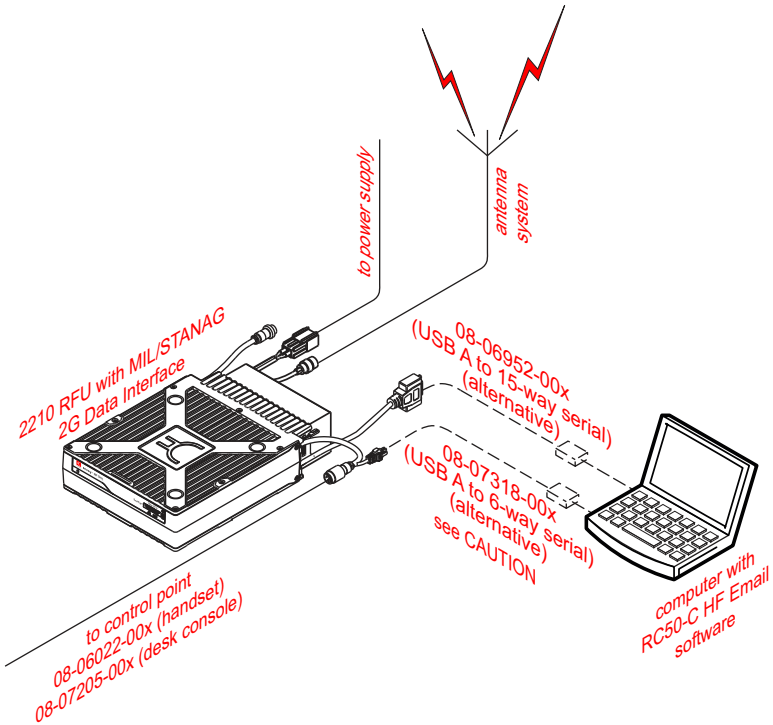

**CAUTION:** If the 6-way port is used with serial cable 08-07318-00x, the **RFU 15way MIL/STANAG 2G Data** peripheral device must not be selected on the 15-way port.



**Figure 23:** Envoy X2 Transceiver with MIL/STANAG 2G Data via VCOM over USB cable

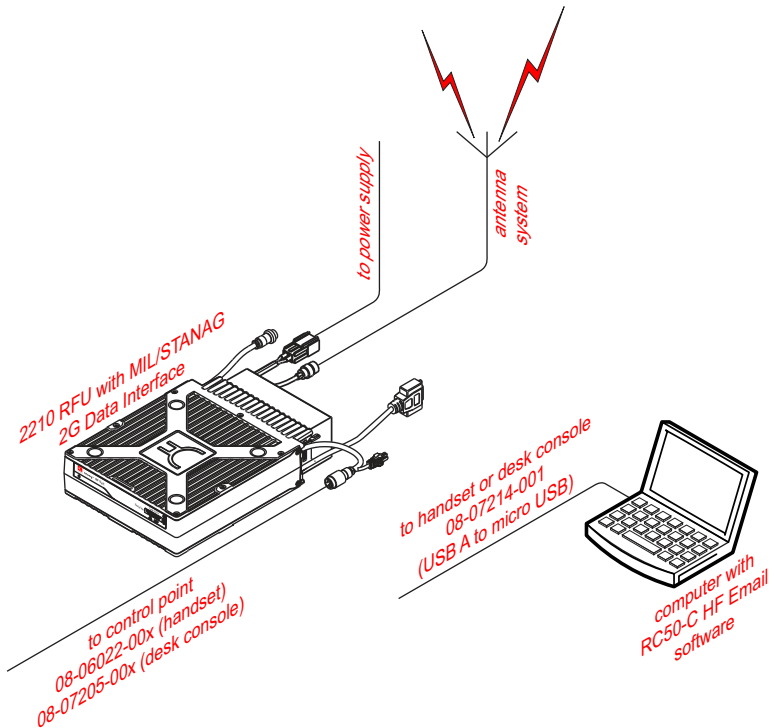

**CAUTION:** When VCOM is used over the USB cable (08-07214-001), the **RFU 6way MIL/STANAG 2G Data** and **RFU 15way MIL/STANAG 2G Data** peripheral devices must not be selected on the respective ports.

**CAUTION:** Data transmitted via a VCOM session over a USB–USB connection may be affected by your computer’s power-saving activities. Either disable the power-saving mode while data is being transmitted, or verify that the data has been sent correctly when the computer wakes from power-saving mode.

**Figure 24:** Envoy X2 Transceiver with MIL/STANAG 2G Data via VCOM over Ethernet cable

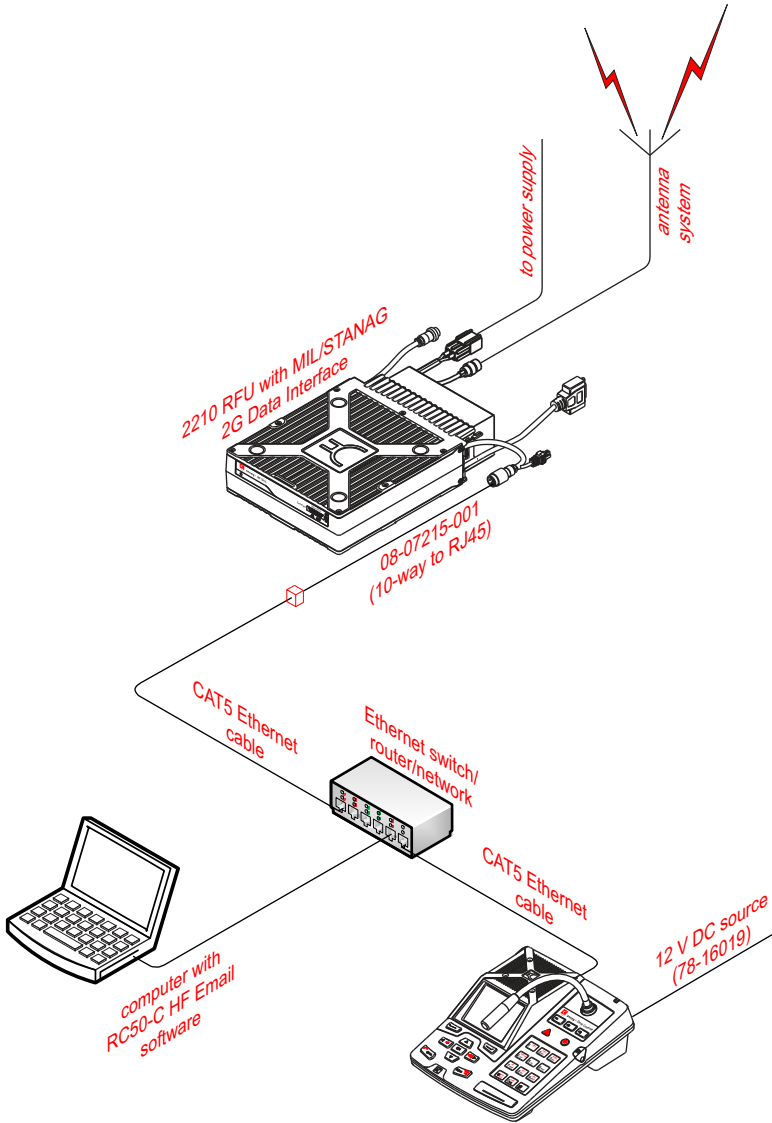

**CAUTION:** When VCOM is used over an Ethernet cable, the **RFU 6way MIL/STANAG 2G Data** and **RFU 15way MIL/STANAG 2G Data** peripheral devices must not be selected on the respective ports.

**NOTE:** For information on setting up the data station, please see the Reference Manual.

## Sending email via RC50-C

An email message is sent via your email client to the RC50-C HF Email software, which passes it to the MIL/STANAG 2G Data processor. The processor passes the message to the transceiver, which transmits it over the air.

To send an email message:

- Launch the RC50-C HF Email software, then click **Go Online** to activate the MIL/STANAG 2G Data processor.

The transceiver responds with a beep.



- Compose your email message in your email client software, for example Microsoft® Outlook®, then send it to the recipient.

When a signal is transferred between the data modems across the link established by the transceivers, the current transmit or receive data rate is indicated on the right-hand side of the **Clear Data** indicator.

While the message is being sent between the transceivers, activity is reported on the screen of the control point.

**Figure 25:** Transmit and receive screens during a MIL/STANAG 2G data call

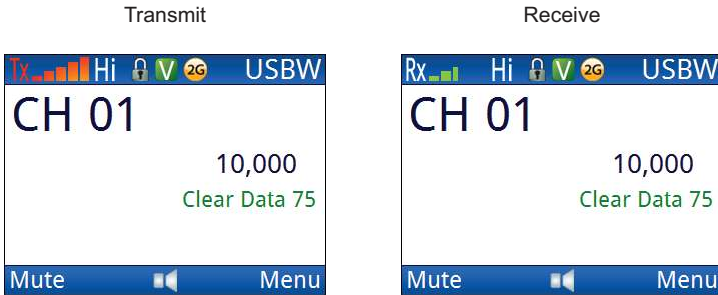

**NOTE:** An AES-256 data encryption upgrade is available for use with the MIL/STANAG 2G Data interface.

**NOTE:** If you go off line in RC50-C, the modem may disconnect for 15 sec, then reconnect.

Related links:

[Using encryption on page 100](#)

## RM50e HF Data Modem

The RM50e HF Data Modem provides data communications. It may also be used to provide high-grade AES-256 digital encryption. It may be used with any data-capable Codan HF transceiver. It must be used in conjunction with the RC50-C HF Email software. The data modem is capable of high-speed data transfer at speeds of up to 9600 bit/s using STANAG 4539 waveforms. The data modem also supports MIL-STD-188-110A/B (including Appendix F), STANAG 4285, STANAG 4529, and STANAG 4415 waveforms.

**NOTE:** When a data application is connected, an icon appears in the status bar of the channel screen (2G).

Related links:

[Using encryption on page 100](#)

## Typical RM50e data station

A typical RM50e data station comprises:

- any data-capable Codan HF transceiver
- an antenna system
- an appropriate 12 V DC power supply
- an RM50e HF Data Modem, selected as a peripheral device
- a computer with RC50-C HF Email software

**Figure 26:** Envoy X2 Transceiver with RM50e HF Data Modem

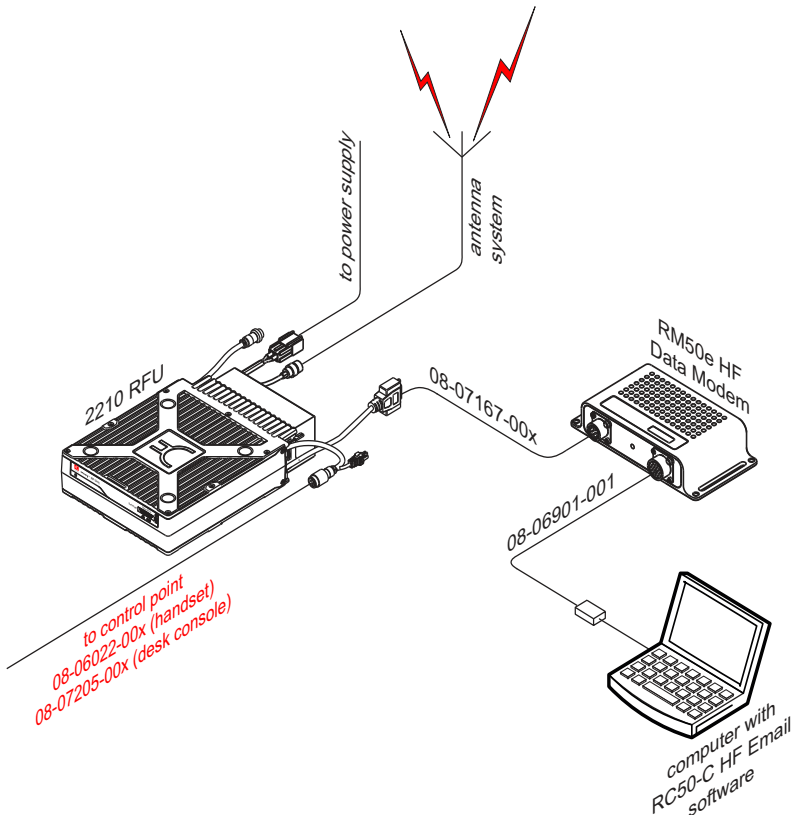

**NOTE:** For more information on setting up and using an RM50e email station, please see the documentation provided with the modem and the RC50-C on-line help.

## Sending email via RC50-C

An email message is sent via your email client to the RC50-C HF Email software, which passes it to the RM50e. The RM50e passes the message to the transceiver, which transmits it over the air. The RM50e can operate in clear or secure mode.

To send an email message:

- Launch the RC50-C HF Email software, then click **Go Online** to activate the RM50e HF Data Modem.

The transceiver responds with a beep.



- Compose your email message in your email client software, for example Microsoft® Outlook®, then send it to the recipient.

When a signal is transferred between the data modems across the link established by the transceivers, the current transmit or receive data rate is indicated on the right-hand side of the **Clear Data** indicator.

While the message is being sent between the transceivers, activity is reported on the screen of the control point.

**Figure 27:** Transmit and receive screens during an RM50e data call

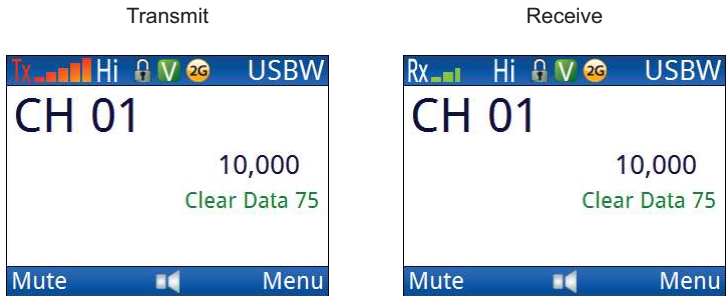



Related links:

[Using encryption on page 100](#)

# Using encryption

You may have access to encryption/scrambling if these options are enabled in your transceiver, and appropriate hardware fitted, if required.





## Switching the secure feature on or off

The 2220 Handset and 2230 Desk Console have a hot key that accesses the secure feature directly. With the 2221 Handset, you access the secure feature by pressing  (**Options**), or via  (**Functions**) on the main menu screen. When you switch on secure mode, all encryptors/scramblers that are activated in your transceiver go secure. When AES-256 DV and data encryptors are used at the same time, they use the same secure key.

If you want secure to remain on at all times, you set this in **Settings > Security > Secure Start State**.

**NOTE:** For detailed information on setting up encryption and scrambling, please see the Reference Manual.

To switch the secure feature on or off:

- If you are using a 2220 Handset or 2230 Desk Console, press **SEC**.
- If you are using a 2221 Handset:
  - Press  (**Options**).
  - Press  or  to scroll to the **Secure On|Secure Off** option.
  - Press  (**Select**).

Secure is toggled on or off across all active encryptors/scramblers.



For CIVS voice scrambling you will see:

Secure (in Rx)



privacy code

Clear (in Rx)

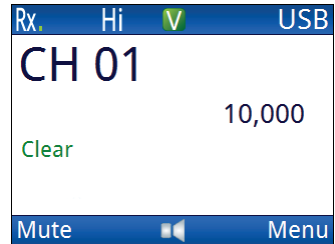

Transmit (while secure)



Receive (while secure)



For CES-128 voice encryption you will see:

Secure (in Rx)

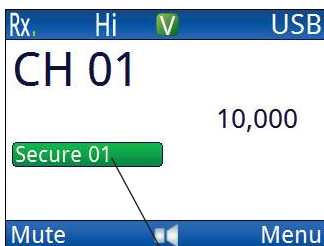

Clear (in Rx)



secure index for  
CES-128 secure key

Transmit (while secure)



Receive (while secure)



For AES-256 digital voice you will see:

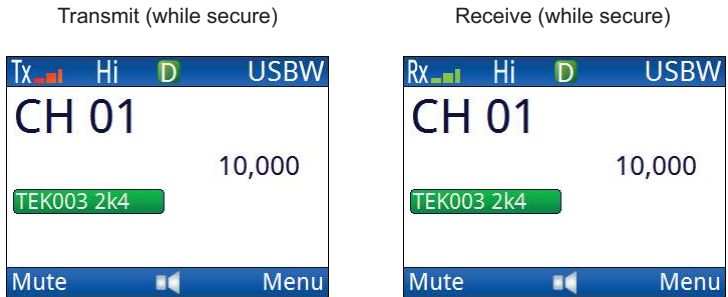
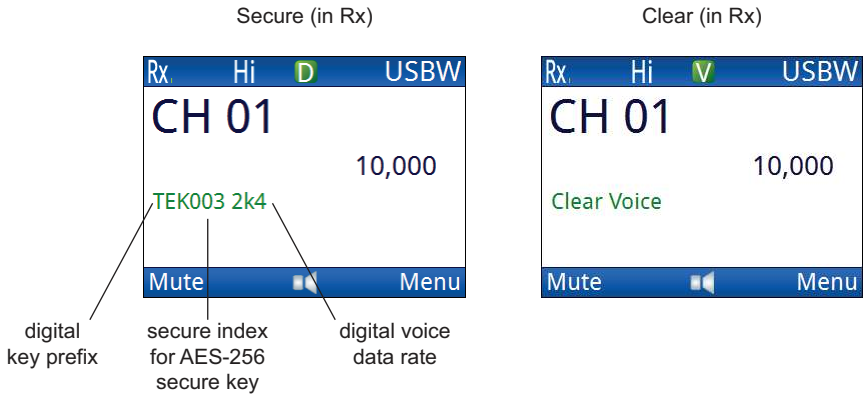

For AES-256 data encryption you will see:

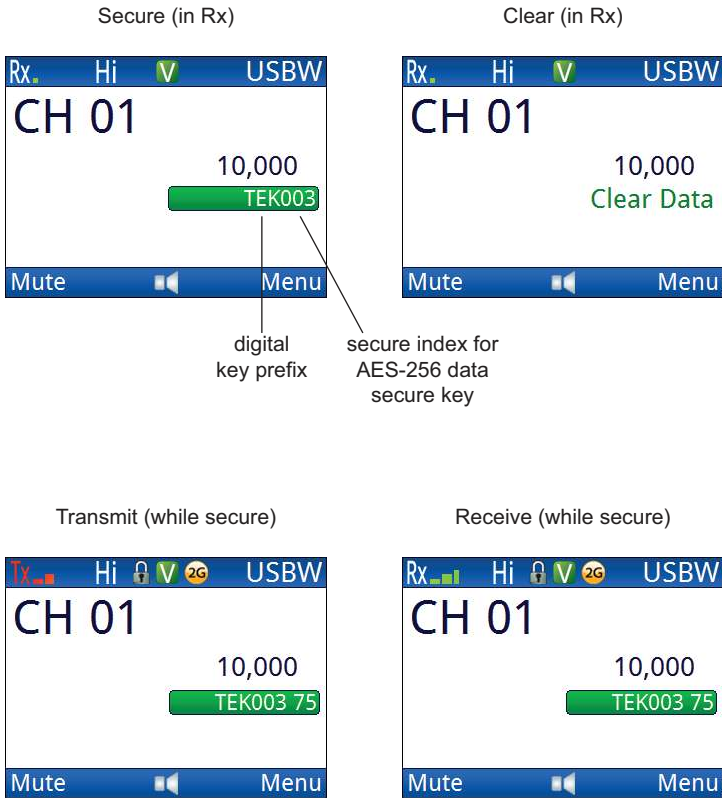





**NOTE:** If you have more than one encryptor/scrambler available for activation, you can change to another encryptor/scrambler, if permitted.

- If you are using CES-128 voice encryption with a 2220 Handset or 2230 Desk Console, press \* to go to secure standby mode, if enabled and required.

Standby





- If you are using CES-128 voice encryption with a 2221 Handset, do the following to go to secure standby mode:
  - Press  (**Options**).
  - Press  or  to scroll to the **Standby On** option.
  - Press  (**Select**).





## Entering a PIN for a secure session

If you have CES-128 voice encryption, you can enter a PIN for a secure session to provide additional privacy, if permitted. Stations must use the same PIN in the session for successful secure communications. The PIN may be entered as you go secure, or while in a secure session. The PIN is valid for the current secure session only.

**CAUTION:** You must re-enter a PIN each time you go secure if you want to use this additional privacy.

To enter a PIN for a secure session:

- If you are using a 2220 Handset or 2230 Desk Console, do *one* of the following:
  - From the main menu, select  (**General**), then  (**Secure**).
  - Hold **SEC**.

- If you are using a 2221 Handset:
  - From the main menu, select  (**Functions**).
  - Press  or  to scroll to the **Secure Info** entry.
  - Press  (**Select**).

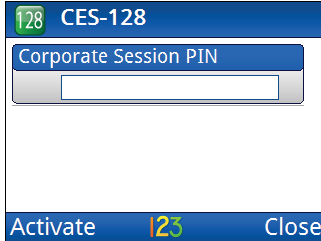









- Enter up to 4 digits.
  - Press  (**Activate**).
- The transceiver goes secure on the selected key.

## Selecting a secure key



If an encryptor contains two or more keys, you have the option of selecting a different key for encryption, if permitted. When AES-256 DV and data encryptors are used together, the selected key is common to both.

To select a secure key:

- If you are using a 2220 Handset or 2230 Desk Console, do *one* of the following:
  - From the main menu, select  (**General**), then  (**Secure**).
  - Hold **SEC**.

- If you are using a 2221 Handset:
  - From the main menu, select  (**Functions**).
  - Press  or  to scroll to the **Secure Info** function.
  - Press  (**Select**).
- Press  or  to scroll to the **Select Key Index** entry.







- Press  or  to select the secure key index that you want to use.  
*Hold* the key to scroll rapidly through the secure key indexes.
  - Press  (**Activate**).
- The transceiver goes secure on the selected key.

## Changing the privacy code

The CIVS scrambler operates on one of 32 codes. You can change the current privacy code, if permitted.

To change the privacy code:

- If you are using a 2220 Handset or 2230 Desk Console, do *one* of the following:
  - From the main menu, select  (**General**), then  (**Secure**).
  - *Hold* **SEC**.

- If you are using a 2221 Handset:
  - From the main menu, select  (**Functions**).
  - Press ▲ or ▼ to scroll to the **Secure Info** function.
  - Press  (**Select**).
- Press ▲ or ▼ to scroll to the **Privacy Code** entry.



- Press ◀ or ▶ to select the code that you want to use.  
*Hold* the key to scroll rapidly through the codes.
- Press  (**Activate**).  
The transceiver goes secure on the selected code.

## Adding a secure key









- NOTE:** Codan's KMS may be used to generate secure keys and to fill the CES and AES DV and data encryptors. KFS may be used to fill keys to these encryptors.
- NOTE:** VCOM is used to provide virtual COM ports for programming secure keys via KMS/KFS over the USB connector on the control point.
- NOTE:** Only one application connected via VCOM may be serviced by the RFU at a time.

If you are permitted to add a secure key for a CES-128 or AES-256 encryptor via the user interface of the control point, the transceiver automatically selects the next empty secure index into which you can enter a secure key. You cannot select the secure key index.





**NOTE:** AES-256 DV and data encryptors use the same secure key.

To add a secure key:

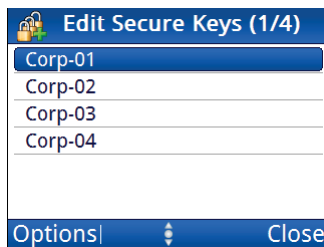

- If you are using a 2220 Handset or 2230 Desk Console, do *one* of the following:
  - From the main menu, select  (**General**), then  (**Secure**).
  - Hold **SEC**.
- If you are using a 2221 Handset:
  - From the main menu, select  (**Functions**).
  - Press  or  to scroll to the **Secure Info** function.
  - Press  (**Select**).
- Press  or  to scroll to the **Edit Keys** entry.
- Press .

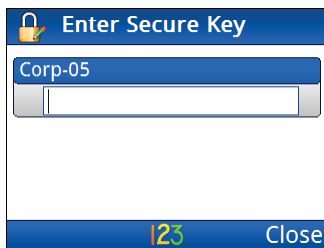

- Press  (**Options**), scroll to **Add**, then press  (**Select**).

**NOTE:** If all secure key indexes contain a key, **Add** is not shown as an option.



- Enter the characters that you want to use for the secure key.
- Press  (**Save**) to save the information.
- Press  (**Close**).

# Using a crosspatch

## Overview of the 3031 Crosspatch

The 3031 Crosspatch is a device that connects an HF communication system with a VHF or UHF communication system.

**NOTE:** The use of the CIVS voice scrambler is not recommended across VHF/UHF to HF communication links.

The operating mode of the crosspatch may be controlled directly by the transceiver, or by using DTMF commands on a DTMF-capable VHF/UHF transceiver.

The crosspatch may be active, on standby, or switched off. The status of the crosspatch is shown in the status bar, and you can set the status to be shown in one of the status areas.

**NOTE:** For information on how to set up what is shown in the status areas, please see the Reference Manual.

**Figure 28:** Crosspatch status

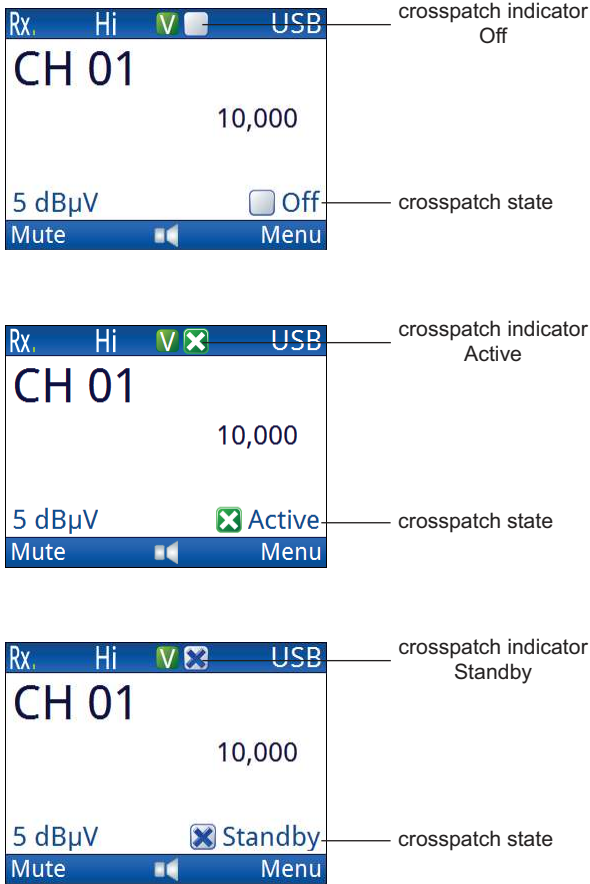





If the crosspatch is selected as the peripheral device for the 15-way connector, but has been disconnected, the crosspatch indicator is no longer shown in the status bar of the channel screen.



## Changing the operating mode of the crosspatch

To change the operating mode of the crosspatch:

- If you are using a 2220 Handset or 2230 Desk Console, press **5**.
- If you are using a 2221 Handset:
  - From the main menu, select  (**Functions**).
  - Press  or  to scroll to the **Next Crosspatch State** function.
  - Press  (**Select**).

The crosspatch toggles between the following states:

- Off 
- Active 
- Standby 

**NOTE:** If the status shows  **Disconnected**, the crosspatch may not be connected.

# Upgrading the transceiver via a USB stick

Firmware packages and profiles from TPS System Programmer, and secure keys from KMS may be loaded onto a USB stick, providing a portable method of upgrading transceivers in the field. You can also read a profile from a transceiver in the field. When the USB stick is connected to the control point, a selection menu is shown for various activities depending on the values set by your system administrator.

If you have multiple control points connected to the RFU during any of the following operations, the control point that initiates the operation displays the progress. All other control points display a message indicating that the RFU is busy.





To manage profiles, firmware, and secure keys:

- Connect your USB stick to the control point using a standard USB A (female) to micro USB cable (Codan part number 67-90406).

The USB stick is detected automatically. A **Select Task** icon () is now available in the main menu screen.

- Enter the correct admin PIN, if requested.
- Press ▲ or ▼ to scroll to the activity that you want to perform:
  - If you want to program a profile from the USB stick to the transceiver, select **Program Profile**.
  - If you want to read the profile from the transceiver to the USB stick, select **Read Profile**.
  - If you want to upgrade the transceiver with a firmware package on the USB stick, select **Upgrade Firmware**.
  - If you want to program secure keys to a transceiver that has an encryptor module enabled, select **Program Secure Keys**.

**CAUTION:** If you have CES and AES DV encryptors present, the keys for these must be programmed simultaneously.

- Do *one* of the following:
  - Press ▲ or ▼ to scroll to the profile, firmware package, or key set file, press  (**Options**), scroll to **Open**, then press  (**Select**).
  - Press ▲ or ▼ to scroll to the folder in which you want to save the profile from the transceiver, then press  (**Save**).
- Press  (**Yes**) to confirm that you want to complete the selected action.
- Perform more tasks with the USB stick as required.
- Press  (**Eject**) when you have finished working with the USB stick.
- Remove the USB stick from the control point.

This page has been left blank intentionally.



---

# 4

# Contacts





This section contains the following topics:

- *Adding a contact on page 118*
- *Adding a contact from the Call Log, Call History, or Last Heard Log on page 125*

# Adding a contact

Contacts are used to pre-define the typical calls that you want to make to another person or organisation, and calls that are made to an emergency contact when the  key is *held* for 2 sec.

To add a contact:

- From the main menu, select  (**User Data**), then  (**Contacts**).
- Select  (**Contacts**) or  (**Emergency Contacts**), as required.
- Press  (**Add**).

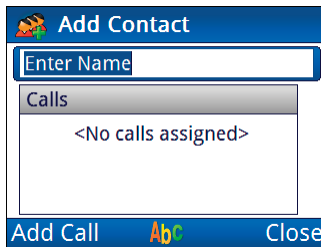

- Enter the name that you want to use for the contact, then press  (**Add Call**).

The **HF Network** entry is highlighted.

The HF network defines the call system and self address that is used by your station when the call is made.

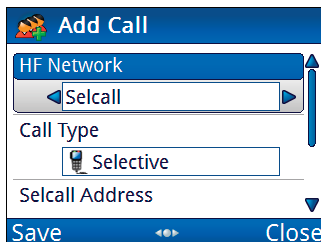

- Press ◀ or ▶ to select the HF network that you want to use.
- Press ▼ to move to the **Call Type** entry.
- Press ◀ or ▶ to select the call type that you want to use.

**NOTE:** The call type that you select affects information that you can enter for the remainder of this call.

- If you are adding:
  - a Selective, Channel Test, Emergency, Get Position or Send Position call, continue from [Adding a simple call on page 119](#)
  - a Message call, continue from [Adding a Message call on page 120](#)
  - a Phone call, continue from [Adding a Phone call on page 122](#)

## Adding a simple call

A simple call requires an address only at this stage of the definition process.

To continue with adding a Selective, Channel Test, Emergency, Get Position or Send Position call:

- Press ▼ to move to the **Selcall/ALE Address** entry.

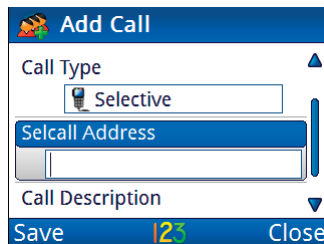

- Enter the address of the station that you want to call.
- Continue from [Completing the contact on page 123](#).

## Adding a Message call

To continue with adding a Message call:

- Press **▼** to move to the **Selcall|ALE Address** entry.

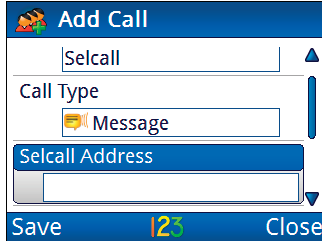

- Enter the address of the station that you want to call.
- Press **▼** to move to the **Message** entry, then press **▶**.

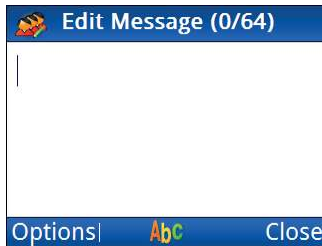

**NOTE:** If you want to be prompted to enter a message at the time of the call, leave the value for the **Message** entry as **<Empty>**.







- If you want to enter a message:
  - *Hold #* to select a different input language, if required.
  - Start typing the message.

**NOTE:** Press **OK** to start a new line, if required.

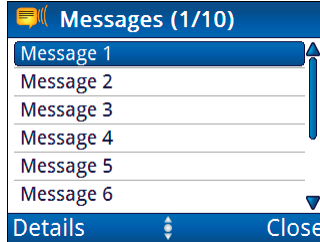

- Press **↵** (**Options**), scroll to **Save**, then press **↵** (**Select**) to add the message to the call.

- If you want to select a message from a list of stored messages:
  - Press  (**Options**), scroll to **Stored**, then press  (**Select**).

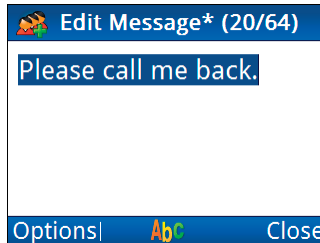

- Press  or  to scroll to the message that you want to use.
- NOTE: If you want to view the message, press  (**Details**) to view the message, then press  (**Close**).
- Press **OK** to select the message.
- Edit the message, if required.



- Press  (**Options**), scroll to **Save**, then press  (**Select**).
- Continue from *Completing the contact* on page 123.

## Adding a Phone call

To continue with adding a Phone call:

- Press ▼ to move to the **Phone Link** entry.

**NOTE:** This entry is shown if there are two or more phone links from which to choose.

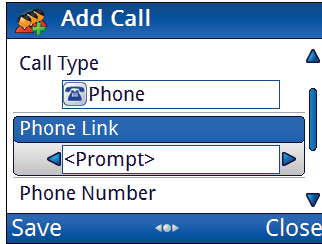



- Press ◀ or ▶ to select the phone link that you want to use, or select **<Prompt>** if you want to be prompted to select a phone link at the time of making the call.
- Press ▼ to move to the **Phone Number** entry.
- Enter the phone number.
- Continue from [Completing the contact on page 123](#).

## Completing the contact

To finish entering the information required for the contact:

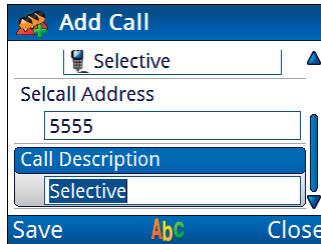
- Press ▼ to move to the **Call Description** entry.  
 The call type is entered automatically as the call description.



- Enter a new description for this call, if required.
- Press  (**Save**) to save the information.
- Press ▼ to move to the **Preferred Channel** entry.

**NOTE:** Selecting a preferred channel is optional. If you communicate with the same contact and call over a 24-hour period, setting a preferred channel may limit effective HF propagation.

**NOTE:** If you do not want to select a preferred channel, leave the setting as **None**.

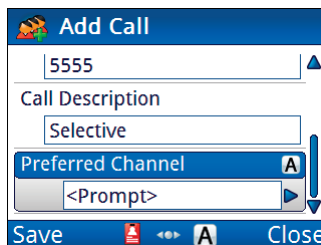

**NOTE:** This entry is not available for Phone calls.

- To select a channel:
  - Press **▶** to view the list of available channels.

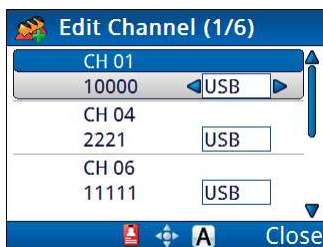

- Press **▲** or **▼** to scroll to the channel that you want to use, then press **OK**.  
A  is shown next to the channel/mode.
- Press **◀** or **▶** to change the mode, if required.

**NOTE:** If you are not able to select a different mode, then only one mode is allowed for this channel. If you want to use a different mode, go to the relevant scan table, duplicate the channel, then select the new mode for this channel.

- Press **↵** (**Save**).
- If you want to add another call, press **↵** (**Options**), scroll to **Add Call**, press **↵** (**Select**), then repeat the steps for adding a call.
- Press **↵** (**Options**), scroll to **Save**, then press **↵** (**Select**).
- Press **↵** (**Close**).



# Adding a contact from the Call Log, Call History, or Last Heard Log

You can save information from the Call Log, Call History, or Last Heard Log to Contacts. This can either be a new call type for an existing contact, or you can add a new contact to hold this call information. The information is transferred automatically, so you do not have to re-enter information.

**NOTE:** Within the Call History, you can also save a call to a contact from one of the filtered lists: Incoming Calls, Outgoing Calls, and Missed Calls.

**NOTE:** An existing contact must be unlocked at the level at which you are making this addition.

**Figure 29:** Call Log, Call History, and Last Heard Log

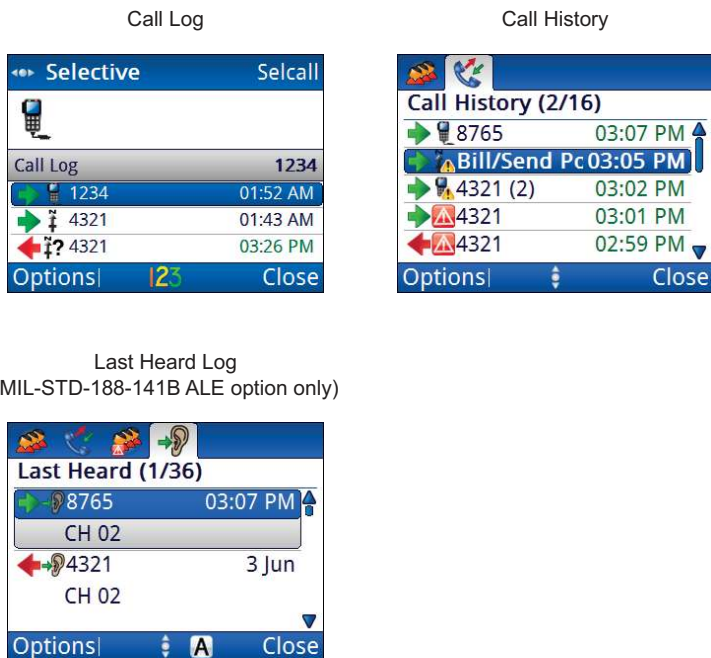

To add a contact from the Call Log, Call History, or Last Heard Log:

- Do *one* of the following:
  - Press **CALL**, then press ▲ or ▼ to scroll to the entry in the Call Log.
  - Hold **CALL**, press ► to select 🌐 (**Call History**), then press ▲ or ▼ to scroll to the entry in the Call History.
  - Hold **CALL**, press 🔌 + 2 to go to advanced view, press ► to select 📶 (**Last Heard**), then press ▲ or ▼ to scroll to the entry in the Last Heard Log.
- Press ⏏ (**Options**), scroll to **Save**, then press ⏏ (**Select**).
- Do *one* of the following:
  - If there is a matching contact who you want to use, press ⏏ (**Yes**), then edit the call as required.
  - If you do not want to use the matching contact, press ⏏ (**No**), create a new contact, then edit the call as required.
  - If there are several matching contacts, scroll to the contact who you want to use, press ⏏ (**OK**), then edit the call as required.
  - If there is no matching contact, edit the call as required.
- Press ⏏ (**Save**) to save the information.
- If the contact does not exist, enter a name for the contact, then press ⏏ (**Save**).

---

# A

# Navigating the menu structure

This section contains the following topics:

- *The basic menu structure* on page 128
- *Navigating the menu structure* on page 130
- *Overview of basic and advanced views* on page 132
- *Finding a word or value* on page 134
- *Selecting an icon* on page 137
- *Selecting a function from the menu bar* on page 138
- *Entering text in a field* on page 140
- *Selecting a value from a list* on page 146
- *Selecting/deselecting a check box* on page 147
- *Moving a slider* on page 148
- *Changing the order of items in a list* on page 149
- *Saving your changes* on page 150

# The basic menu structure

The menu structure comprises a main menu and a series of submenus that are accessed via the main menu. Each menu and submenu is represented by an icon. Some icons provide direct access to an input/view screen, while other icons provide a list of entries for the menu.

**NOTE:** Your system administrator is able to hide icons (and the associated menus) so that they do not appear at user level, and therefore, cannot be accessed at user level.

**Figure 30:** Typical menu screen

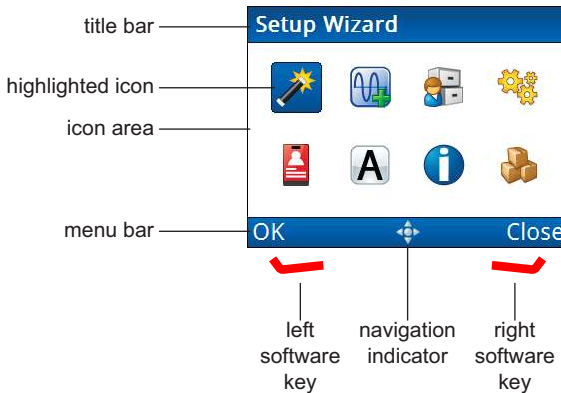

When an icon is highlighted, the name of the icon is shown in the title bar of the screen. For example, when the  icon is highlighted, **Setup Wizard** is shown in the title bar.

**Figure 31:** Menu structure (user level, basic view)

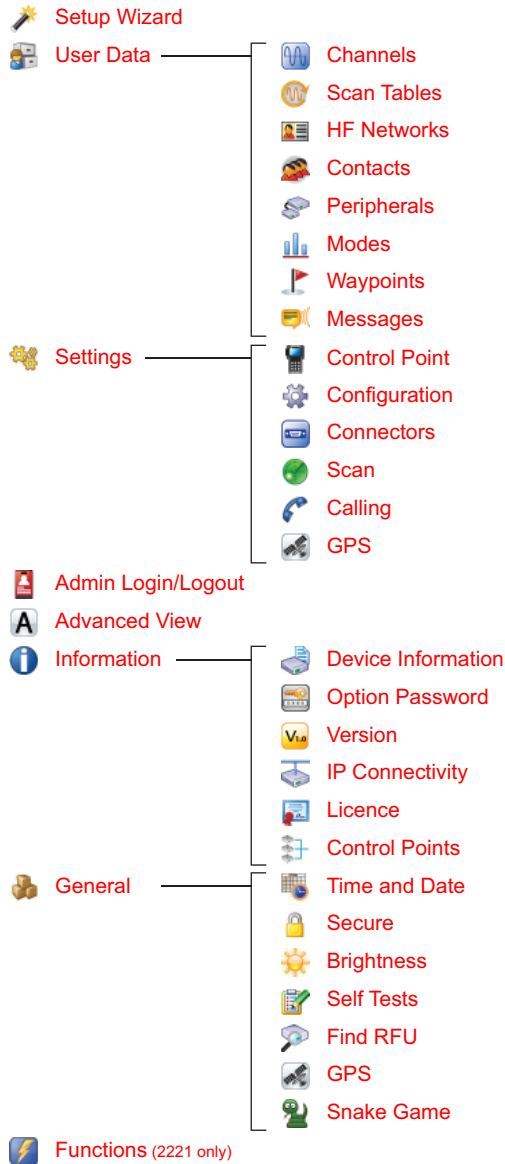

The menu items may contain further submenus and lists of entries. Each entry either has specific values from which you may choose, or you may enter the information required.

# Navigating the menu structure

The menu structure comprises a main menu and a series of submenus that are accessed via the main menu. Navigation keys enable you to highlight an icon, then press **OK** to select that menu. You can continue drilling down through the menu structure in this way. At the lowest level of the menu structure there is either an input/view screen, or a list of entries.

Navigation is available when the navigation indicator is shown in the menu bar at the bottom of the screen.

**Figure 32:** Navigation indicator showing navigation keys that may be used

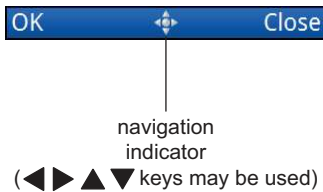

**NOTE:** This icon alternates with operational status icons that indicate when the RFU is busy with an activity from a control point in a multiple control point system.



To navigate the menu structure:

- To move down through the menu structure:
  - Press ◀, ▶, ▲ or ▼ to highlight the icon that you want to select.

The name of the icon appears in the title bar of the screen.

**NOTE:** If the right-most icon is highlighted when you press ▶, the highlight wraps to the first icon in the next row of icons.

**NOTE:** If the left-most icon is highlighted when you press ◀, the highlight wraps to the last icon in the previous row of icons.

- Press **OK**.
- Continue moving down through the menu structure by highlighting the icon that you want, then pressing **OK**.
- To move through a list of entries at the lowest level of the menu structure, press ▲ or ▼.
- To go to the top level in the menu structure, do *one* of the following:
  - Press PTT to exit to the channel screen, then press  (**Menu**) to enter the top level of the menu structure.
  - Press  to return to the top level of the menu structure, one level at a time.

# Overview of basic and advanced views

There are two views of information in the user interface of the control point: basic and advanced. The contents of basic and advanced views are pre-determined and cannot be changed.

## Basic view

Basic view provides a condensed view of the user interface, and typically the view at which the control point is operated. When you power up the transceiver, the control point enters basic view. Basic view is indicated by the absence of an advanced view indicator in the menu bar.

**Figure 33:** Basic view (no advanced view indicator)



Basic view provides access to items that are likely to be changed on a regular basis, or the user may want to change to suit their preferences for the day-to-day operation of the transceiver. The user can switch to advanced view to access items that they may want to change occasionally. The user should switch back to basic view to simplify the view of information presented on the screen of the control point.

## Advanced view

Advanced view provides access to additional settings that may need to be changed occasionally, but are not required in the day-to-day operation of the transceiver. Generally, the control point of the transceiver is in basic view so you must switch to advanced view. Advanced view is indicated by the presence of the advanced view indicator in the menu bar.



**Figure 34:** Advanced view

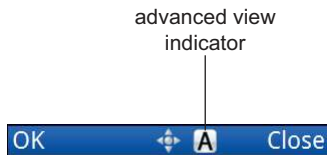

## Switching between basic and advanced views

The user can switch between basic and advanced views to either:

- simplify the user interface of the control point (basic view), or
- access advanced settings that they are permitted to change (advanced view)

To switch between views:

- Press  until the main menu screen is shown.
- From the main menu, select **A (Advanced View)**.

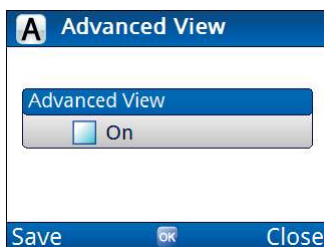

- Press **OK** to toggle advanced view on or off as required.
- Press  (**Save**).

**NOTE:** You can also use the  + **2** hot-key sequence to toggle the user interface between basic and advanced views.

# Finding a word or value

The quickest way to find an entry or a value in the user interface of the control point is to use the **Find** function, which is available via the  key when the highlighted icon contains submenus or lists of entries. The feature searches for the sequence of characters (letters, numbers, or a combination of both) that you enter.

**NOTE:** The **Find** function only searches on words and values that are visible to the user at the current view and level of access.

**Figure 35:** Find function



To find a word or value:

- *Highlight* the icon that represents the highest level in which you want to search, then press  (**Find**).

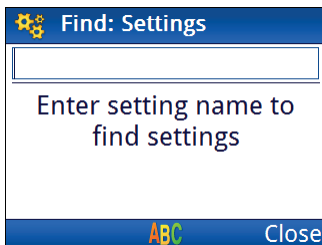

**NOTE:** If you select the icon by pressing **OK**, you will enter that menu level. If you do not want to search at the lower level, press **↵** (**Close**) to return to the higher level, then press **↵** (**Find**) again.



- Enter the letter or number on which you want to search.

Any entries or values that contain the character you have entered are shown in a list, with the character highlighted.

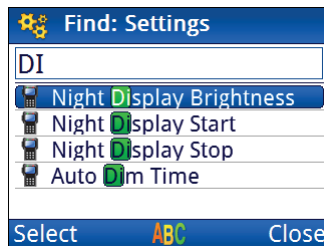

- Enter more characters to refine your search.



The icon that is shown with each item in the list indicates the location of the information. For example, if  appears next to the item, then it is located in **Channels**. If there is another item with  next to it, then it is located in **HF Networks**.

- Scroll to the entry or value that you want to select.



- Press **OK**.  
You are taken to the entry, or the name level of the user data containing the character.

# Selecting an icon

The top levels of the menu structure are represented by icons. In order to enter the menu represented by the icon, you need to select the icon.



**Figure 36:** Highlighted icon



To select an icon:

- Use ◀, ▶, ▲ and ▼ to highlight the icon that you want to select.
- Press **OK** or  (**OK**) to select the icon.



## Selecting a function from the menu bar

The menu bar at the bottom of the screen provides varying functions, depending on the context. You can select a function directly, or activate a pop-up from the menu bar by pressing the corresponding key (  or  ). A vertical line next to the text indicates that there are a number of choices from which to choose. Typically, you can add, edit, move, delete, save, duplicate, and clear items specific to your current location in the user interface.

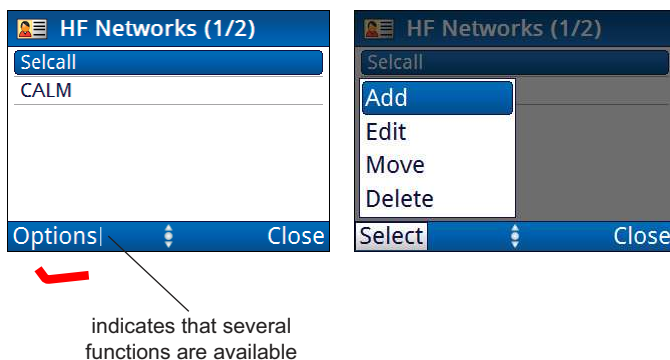
**Figure 37:** Functions on the menu bar



To select a function from the menu bar:

- Press  or , corresponding to the function that you want to select.

If the function in the menu bar does not have a vertical line next to it, the function is performed immediately.

If the function in the menu bar has a vertical line next to it, a pop-up is shown.

- If a pop-up of available functions is shown:
  - Press ▲ or ▼ to scroll to the function that you want to select.
  - Press  (**Select**).  
The function is performed.
- If you want to close the pop-up and not perform any of the functions, press the opposite software key (typically **Close**).

## Entering text in a field

You may need to enter text into a field within an entry. This may be a name given to some user data, or it may be a specific value, such as a frequency. When you first enter an editable text field, either by selecting a menu or using the ▲ and ▼ navigation keys, any existing text that you can edit is highlighted. You can use this text, edit this text, or delete this text and enter new text.

**Figure 38:** Example of an editable text field

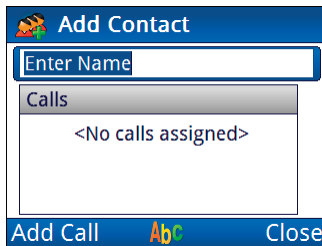

To enter text in a field:

- Navigate to a field in which you can edit text.
- If you want to change the input language:
  - Hold #.
  - Press ▲ or ▼ to scroll to the input language that you want to use, then press **OK**.
  - Press  (**Save**).
- Do *one* of the following:
  - To use this text, press ▼.
  - To delete this text, start entering new text.
  - To edit this text, press ► to place the cursor at the end of the text.



- Press **#** repeatedly to select the character-entry mode that you want to use.

The indicator for the character-entry mode is shown in the centre of the menu bar.

**NOTE:** The character-entry mode indicators are specific to each language selection.

**NOTE:** The input language may be different from the language selected for the user interface.

**Figure 39:** Character-entry mode indicator

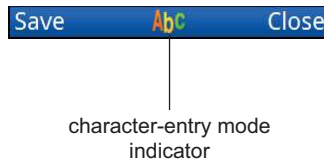

**Table 7:** Character-entry mode

Character-entry mode	Indicator (English)
All upper-case letters	ABC
All lower-case letters	abc
Sentence-case letters	Abc
Numbers	123

- Do any of the following:
  - Press ◀ or ▶ to move the cursor to the point at which you want to enter text.
  - Press ← (on **SCAN** key) to delete text to the left of the cursor.
  - *Hold* ← to delete the whole entry.
  - Press the key on the keypad that corresponds to the letter that you want to enter.  
For example, if you want to enter the letter E, press **3** twice.  
After a brief pause, the cursor moves to the next space, ready to enter another character.

**NOTE:** If you are in a letter-entry mode and want to enter a number, *hold* the key corresponding to the number that you want to enter.

- Press ▼ to move to the next entry.

Related links:

[Entering text with the 2221 Handset on page 144](#)

## Entering a special character (2220/2230)

You can enter special characters in messages, names, contacts, and in addresses of stations that you call.

**NOTE:** If the FED-STD-1045 ALE/CALM option or MIL-STD-188-141B ALE option is installed in your transceiver, the \* key may be used to enter the global ALL address syntax (@?@) or special ALE addressing characters easily.

To enter a special character in an address, message or contact:

- Press ◀ or ▶ to move the cursor to the point where you want to insert a special character.
- Press \* to cycle through the available choices or *hold* \* to see the available special characters.

Depending on the context, you can select from:

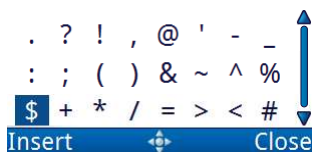

- Press ▲, ▼, ◀ or ▶ to highlight the character that you want to use, then press  (**Insert**).
- Repeat as required.

## Entering text with the 2221 Handset

The 2221 Handset does not have alphanumeric keys, however, you can still enter text into fields within the user interface.

**CAUTION:** This process describes how to enter text into an entry field using the virtual keypad, then save the text back to the entry. At this point, the change to the entry itself has not been saved.

To enter text:

- Navigate to an entry in which you can enter text, then press **OK** to see the virtual keypad.

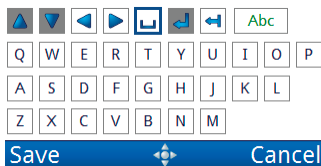

**NOTE:** The English version is shown, however, virtual keypads exist for other supported languages.

- Press ◀, ▶, ▲ or ▼ to move the highlight to the character that you want to select, then press **OK**.
- If you want to change the input language:
  - Highlight **Abc**, then *hold* **OK**.
  - Press ▲ or ▼ to scroll to the input language that you want to use, then press **OK**.
  - Press **Save** (Save).
- If you want to change case, enter a number, or enter a special character, scroll to **Abc**, then press **OK** until you see the character-entry mode that you want to use.
- Continue entering text in this manner.

- Press  (**Save**) to save the information.  
You are returned to the entry.
- Continue with making changes to the item that you are editing, if required.

## Selecting a value from a list

When you select an entry that has a list of values, either by selecting an icon or using the ▲ and ▼ navigation keys, the field is highlighted to show that it can be edited, and ◀/▶ indicators appear on one or both sides of the field to show that multiple values are available.

**Figure 40:** List of entries, with and without focus

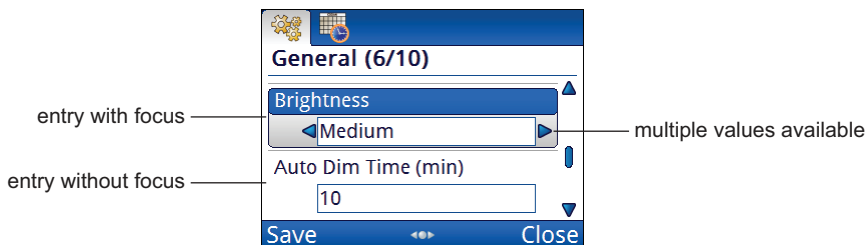

To select a value from a list:

- Navigate to an entry in which you can select a value.
- Press ◀ or ▶ to select the value that you want to use.
- Press ▼ to move to the next entry.

# Selecting/deselecting a check box

There are some entries in the menu structure that require you to enable or disable a particular feature via a check box.

**Figure 41:** Entry with a check box

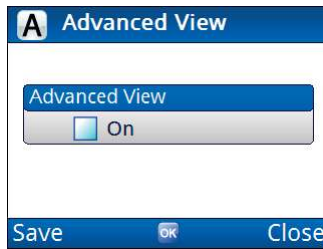

To select or deselect a check box:

- Highlight the entry.
- Press **OK** to toggle the check box as selected or deselected.

When the check box is selected, the item is enabled. When the check box is clear, the item is disabled.

- Press  (**Save**) to save the information.

# Moving a slider

Some values in the user interface of the control point are represented by a slider.

**Figure 42:** A slider value

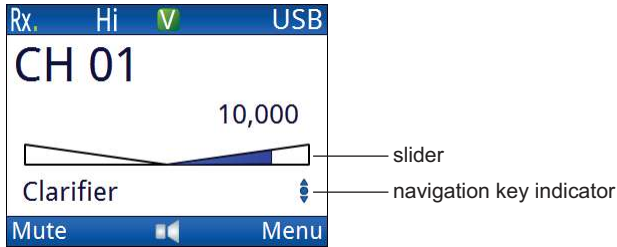

To move a slider:





- Press any of the navigation keys suggested in the navigation key indicator to adjust the slider.



# Changing the order of items in a list

In some areas of the user interface of the control point, you are able to change the order in which items appear in a list, which impacts how the item is viewed, or when each item may be used.

To change the order of items in a list:

- Highlight the item that you want to move.
- Press  (**Options**), scroll to **Move**, then press  (**Select**).
- Press  or  to move the item to the new position in the list, then press  (**Place**).



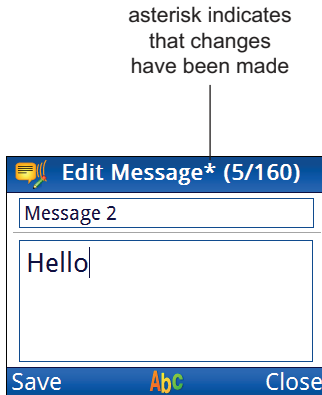

# Saving your changes

When information in an item has been changed, either by editing existing text or selecting a different value from a list, an asterisk is added to the title of the screen.

**Figure 43:** Screen that has changes to be saved



To save changes:

- Do *one* of the following:
  - Press  (**Save**).
  - Press  (**Options**), scroll to **Save**, then press  (**Select**).
- If you do not want to save the changes, do *one* of the following:
  - Press  (**Close**), then press  (**Yes**) to discard the changes.
  - Press PTT to exit to the channel/scanning screen without saving changes.

---

# B

## Structure of information

This section contains the following topics:

- *Structure of user information on page 152*
- *Structure of contact and call information on page 154*

# Structure of user information

Information in the Envoy Transceiver is stored like blocks in a building. Basic blocks are populated with information first, then these blocks, along with different blocks, are assembled into larger blocks. Ultimately, one of the top-level blocks is used to make a call.

The most basic block is a frequency. A frequency is combined with a mode, say USB or LSB, and a name to become a channel. Channels may be grouped into scan tables. Scan tables may be allocated to HF networks. An HF network defines the call system by which a call is made and the self address of the transceiver.

Further blocks may be assembled for the convenience of the user. A contact stores information on the typical calls that can be made to a person or organisation. Each call is defined by the HF network and the call type.

How these blocks are assembled is up to the system administrator. There is, of course, finer detail that needs to be included, however, the basic structure of information in the transceiver is shown in [Figure 44](#).

**Figure 44:** Basic structure of information in the Envoy Transceiver

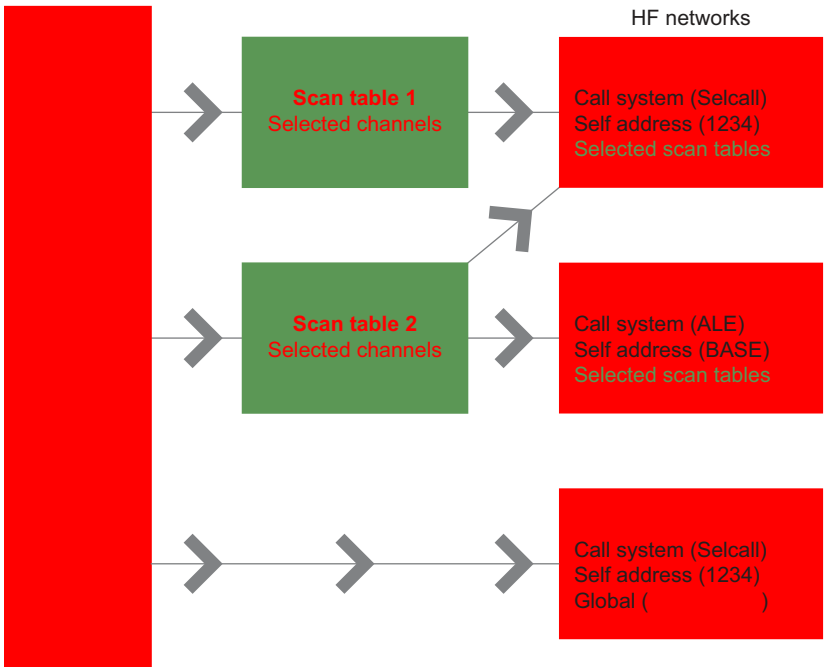

# Structure of contact and call information

A contact holds information on calls that you make to a particular person or organisation. You may have several methods of calling the same contact. Each method that you use is bundled into a call for that contact. The basic building blocks that you require to define a call to a contact is the HF network that will be used, the type of call that you want to make, and the address or telephone number at which the person or organisation will answer the call. The basic structure of call information in a contact is shown in [Figure 45](#).

**Figure 45:** Structure of call information for a contact in the Envoy Transceiver

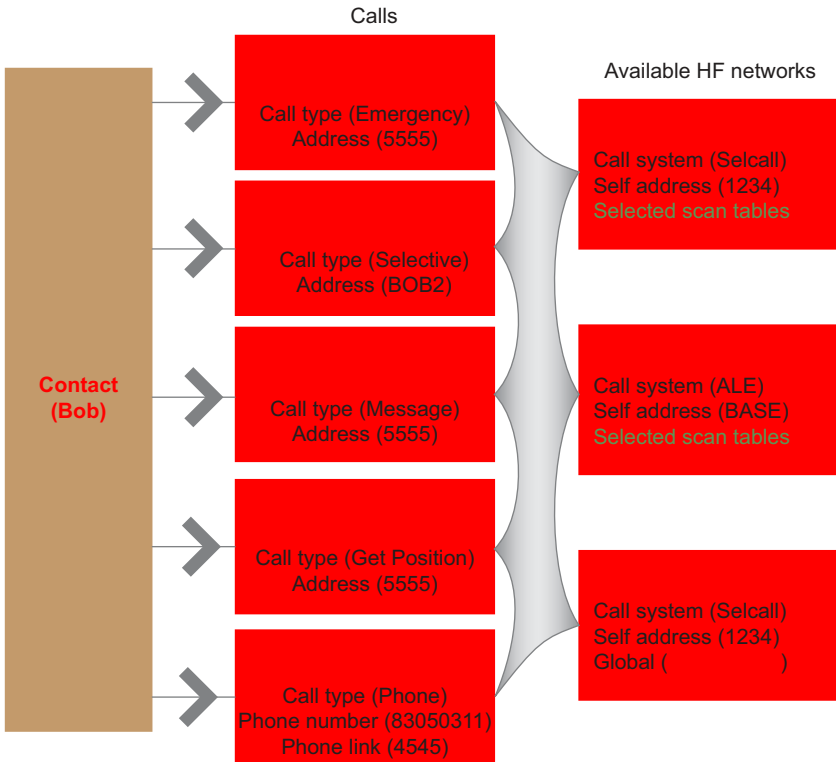

---

# C

## Installing the transceiver

This section contains the following topics:

- [Overview of mobile stations on page 156](#)
- [Overview of fixed stations on page 162](#)

# Overview of mobile stations

A mobile station typically consists of an RFU, a handset, a 12 V DC power supply (battery), an antenna, control and accessory devices, ancillary equipment, and appropriate connecting cables. The antenna is connected to the transceiver by coaxial cable. An automatic tuning antenna also requires a control cable connected to the transceiver.

**Figure 46:** Typical mobile station

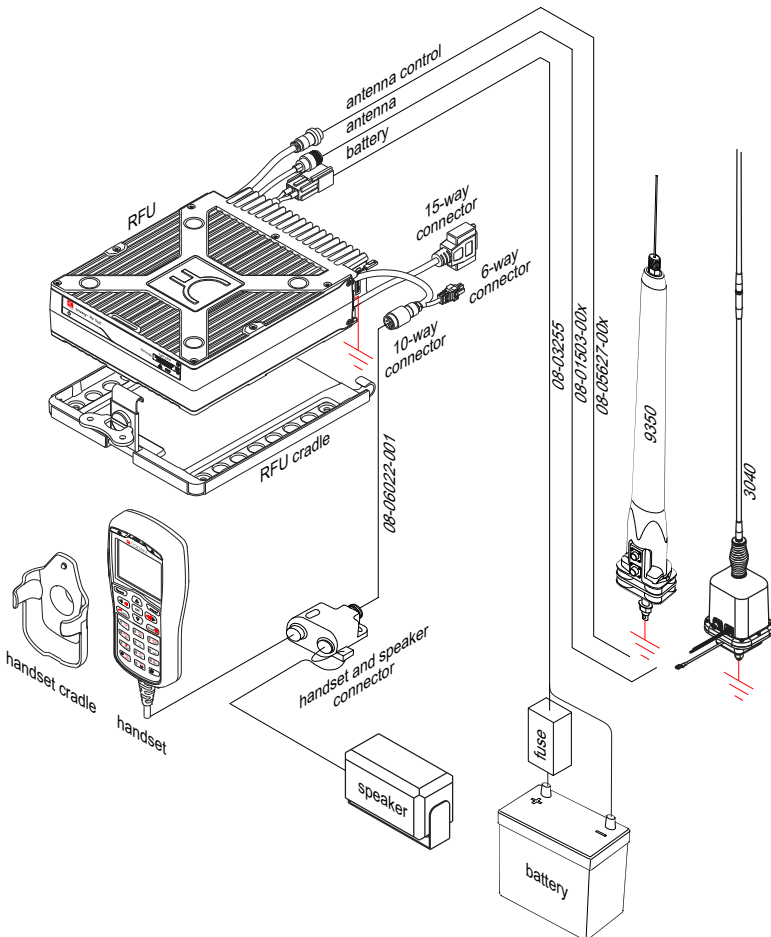



**NOTE:** A range of ancillary equipment may be connected to the Envoy Transceiver using the 6-way and 15-way connectors at the rear of the RFU.

## Cables in a mobile station

**Table 8:** Cables for a typical mobile Envoy™ station

Cable	Symbol	Part number
Handset and speaker connector		08-06022-001
Coaxial cable between RFU and antenna	⋮	08-01503-006
Control cable between RFU and antenna	⋈	08-05627-006
DC power supply cable		08-03255

**NOTE:** Cables 08-06022-001 and 08-03255 are 6 m cables only. Cables 08-01503-006 and 08-05627-006 are 6 m cables and are available in a number of shorter and longer lengths.

## Mounting a mobile Envoy™ station

Most components of a mobile Envoy™ station are provided with their own mounting cradles. For general guidance on suitable locations for equipment and installing these stations see the reference material on the enclosed CD.

### Mounting the handset cradle

To mount the handset cradle:

- Mount the handset according to the fitting instructions (Codan part number 15-00149-001) provided with the handset cradle.

## Mounting the speaker

To mount the speaker:

- Secure the mounting cradle to the surface with at least two screws.  
Ensure there is sufficient space at the rear for the cable.
- Attach the speaker to the cradle with the two screws and rubber washers.

## Mounting the handset and speaker connector

To mount the handset and speaker connector:

- Use cable ties or screws to secure the handset and speaker connector in a suitable location.

## Mounting the RFU

**CAUTION:** If you are transferring a fixed station to a mobile station and you have attached rubber feet to the bottom of the RFU, you must remove the rubber feet before installing it into the mounting cradle.

To mount the RFU:



- Secure the mounting cradle to the surface with at least four screws, one in each corner of the cradle.  
**NOTE:** Ensure there is sufficient space at the rear of the cradle to clear the RFU heatsink.
- If the key is locked to the base of the cradle, flip the key away from the base until it can be rotated (see [Figure 46](#)), then rotate the key in a counterclockwise direction.

- Place the RFU into the cradle and push it under the tabs at the rear of the cradle, then hold the clamp against the front of the RFU.
- Rotate the key clockwise, then push the key toward the base of the cradle to lock the RFU into position.

## Connecting a mobile Envoy™ station

NOTE: A typical mobile station is shown in [Figure 46](#).

To connect a mobile station:

- Connect the cable (Codan part number 08-06022-001) from the handset and speaker connector to the 10-way plug on the cable lead from the RFU, then secure the locking ring tightly into position.
- Connect the plug of the handset cable to the  socket on the handset and speaker connector, then secure the locking ring tightly into position.
- Connect the plug at the end of the speaker cable to the  socket on the handset and speaker connector, then secure the cable by pushing it into the slot on the side of the connector.
- Connect the plug at the end of the Y cable (Codan part number 08-01503-00x) to the socket at the end of the Y cable lead from the RFU, then secure the locking ring tightly into position.
- Connect the plug at the opposite end of the Y cable (Codan part number 08-01503-00x) to the socket located at the base of the antenna, then secure the locking ring tightly into position.

## Connecting the control cable to an automatic tuning antenna

To connect the control cable to an antenna:

- Connect the socket at the end of the ⚡ cable (Codan part number 08-05627-00x) into the plug at the base of the antenna, then secure the locking ring tightly into position.
- Fit the plug at the opposite end of the ⚡ cable (Codan part number 08-05627-00x) into the socket at the end of the ⚡ lead from the RFU.

## Connecting the power supply

To connect the transceiver to the battery power supply:

- If you are using a 24 V battery supply, connect the battery to a 24 V to 12 V voltage regulator (Codan part number 15-00508).
- Connect the power supply cable (Codan part number 08-03255) to the plug at the end of the **12 V** cable lead from the RFU.
- Route the power supply cable according to the instructions supplied with the Vehicle Installation Kit (Codan part number 15-00112).
- Insert the 32 A fuse and holder in the power supply cable at a convenient location, as close as possible to the battery terminals.
- Connect the power supply cable to the battery terminals, black to negative, red to positive.

## Earthing the transceiver

For information on earthing a mobile station, see the Installation section in the Reference Manual.

## Earthing the antenna

For information on earthing a mobile antenna, see the documentation provided with the antenna.

## Overview of fixed stations

A fixed station typically consists of an RFU, a desk console, an AC transceiver supply connected directly to the mains, an antenna, control and accessory devices, ancillary equipment, and appropriate connecting cables. The transceiver is connected to the DC output lead of the transceiver supply. The antenna is connected to the transceiver by coaxial cable.

**NOTE:** A fixed station may also be powered via a battery system or solar power system.

Figure 47: Typical fixed station

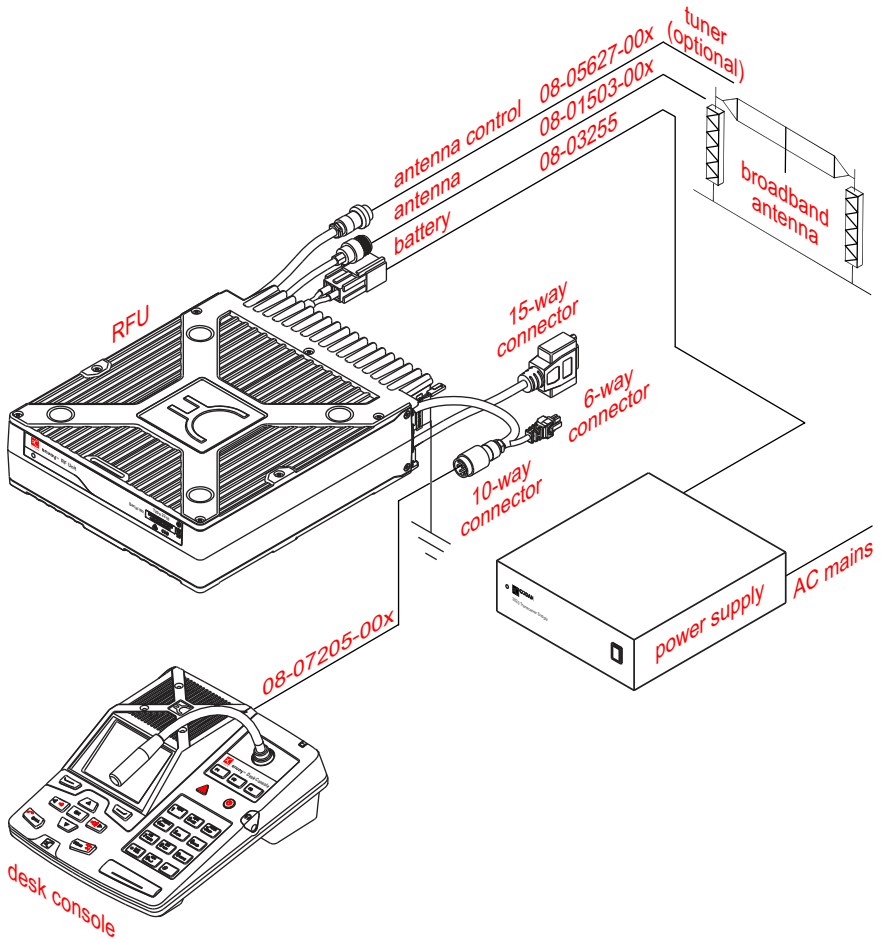

**NOTE:** A range of ancillary equipment may be connected to the Envoy Transceiver using the 6-way and 15-way connectors at the rear of the RFU.

## Cables in a fixed station

**Table 9:** Cables for a typical fixed Envoy™ station

Cable	Symbol	Part number
Cable between RFU and 2230 Desk Console		08-07205-xxx
Handset and speaker connector and cable (optional)		08-06022-001
Coaxial cable between RFU and antenna	‡	08-01503-006

**NOTE:** Cable 08-06022-001 is a 6 m cable only. Cable 08-01503-006 is a 6 m cable and is available in a number of shorter and longer lengths.

## Mounting a fixed Envoy™ station

A fixed Envoy™ station uses a 2230 Desk Console. For general guidance on suitable locations for equipment and installing the fixed station see the reference material on the enclosed CD.

### RFU and transceiver supply

The RFU and the transceiver supply are self-contained and are usually stacked loosely. If you want to mount the RFU and/or the transceiver supply, contact your Codan representative to obtain a rack-mounting unit or the appropriate mounting cradles.

**CAUTION:** If you are mounting an RFU in a cradle, do not fit rubber feet to the bottom of the RFU.

**NOTE:** If you are transferring a mobile station to a fixed station, and you are not mounting the RFU in a cradle, rubber feet can be fitted to the bottom of the RFU. The rubber feet are available from Codan (Codan part number 30-11208-000).



## Rack-mounting unit

A rack-mounting unit consists of a 19 inch rack tray. It can be used to mount your fixed station with either a desk console or the handset and cradle.

## Connecting a fixed Envoy™ station

**NOTE:** A typical fixed station is shown in [Figure 47](#).

To connect a fixed station:

- Do *one* of the following:
  - Connect cable 08-07205-00x between the Transceiver connector on the 2230 Desk Console and the 10-way plug on the flying lead from the RFU, securing the locking rings tightly into position.





**CAUTION:** If the desk console is connected to the RFU via cable 08-07205-00x, ensure that an Ethernet cable is not connected to the RJ45 connector on the rear of the desk console.

- Connect cable 08-07215-001 between the Ethernet connector on the 2230 Desk Console, or an optional switch/router, and the 10-way plug on the flying lead from the RFU, securing the locking ring tightly into position.

**CAUTION:** If the desk console is connected to the RFU via an Ethernet cable and cable 08-07215-001, ensure that cable 08-07205-00x is not connected to the 8-way connector (🔌) on the rear of the desk console.

**NOTE:** If a switch/router is used, an additional RJ45 cable is required to connect between the switch/router and the desk console.

- Connect the lead from the handset and speaker connector to the 10-way plug on the flying lead from the RFU, then secure the locking ring tightly into position.



- If you are using the handset and speaker connector and cable:
  - Connect the plug of the handset cable to the  socket on the handset and speaker connector, then secure the locking ring tightly into position.
  - Connect the plug at the end of the speaker cable to the  socket on the handset and speaker connector, then secure the cable by pushing it into the slot on the side of the connector.
- Connect the plug at the end of the  cable to the socket at the end of the  cable lead from the RFU, then secure the locking ring tightly into position.
- Connect the plug at the opposite end of the  cable to the socket located at the base of the antenna, then secure the locking ring tightly into position.

### Connecting an automatic tuner to the RFU and antenna (optional)

Typically, fixed stations are installed with a broadband antenna, which does not require a tuner. Some fixed stations may not have sufficient room to install a broadband antenna, so a smaller antenna with an automatic tuner may be used.

**NOTE:** The tuner used in most applications has connectors at the end of the cables attached to the tuner, as described below, however, you may have a tuner that has sockets on the connector panel of the tuner.

To connect the tuner to the RFU:

- Connect the plug at the end of the coaxial cable from the tuner to the socket at the end of the  cable lead from the RFU, then secure the locking ring tightly into position.
- Connect the plug at the end of the control cable from the tuner to the socket at the end of the  cable lead from the RFU, then secure the locking ring tightly into position.
- Connect the antenna to the antenna connector on the tuner, then secure it tightly into position.

## Connecting the transceiver supply

To connect the transceiver to the transceiver supply:

- Connect the DC output from the transceiver supply to the plug at the end of the **12 V** cable lead from the RFU.
- Connect the transceiver supply to the AC mains supply.

## Earthing the transceiver

For information on earthing a fixed station, see the Installation section in the Reference Manual.

## Earthing the antenna

For information on earthing a fixed antenna, see the Installation section in the Reference Manual.

This page has been left blank intentionally.

# D

# Specifications

**Table 10:** Specifications

Item	Specification
Frequency range	Transmit: 1.6 MHz to 30 MHz Receive: 0.25 MHz to 30 MHz
Channel capacity (single or two-frequency simplex channels)	X1: 100 (International) 400 (Australia) X2: 1000
Operating modes	Single sideband (J3E) USB and LSB or switched USB/LSB, AM (A3E Rx, H3E Tx), CW (J1A, A1A)
Environment	Ambient temperature: -30°C to +60°C (-22°F to 140°F) Relative humidity: 95% Derate upper ambient temperature by 1°C (1.8°F) per 330 m (360 yd) above sea level
Cooling	Convection or fan (Option F)

**Table 10:** Specifications (cont.)

Item	Specification
Size	<p>2210 RFU: 210 mm W × 270 mm D × 65 mm H (8.4 in W × 10.8 in D × 2.6 in H)</p> <p>2220/2221 Handset: 74 mm W × 32 mm D × 150 mm H (2.9 in W × 1.3 in D × 5.9 in H)</p> <p>2230 Desk Console: 190 mm W × 233 mm D × 81 mm H (7.5 in W × 9.2 in D × 3.2 in H)</p> <p>Handset and speaker connector: 42 mm W × 55 mm D × 22 mm H (1.7 in W × 2.2 in D × 0.9 in H)</p>
Weight	<p>2210 RFU: 2.8 kg (6.2 lb)</p> <p>2220/2221 Handset: 0.3 kg (0.7 lb)</p> <p>2230 Desk Console: 1.1 kg (2.4 lb)</p> <p>Handset and speaker connector: 0.4 kg (0.9 lb)</p>
Sealing	All units: IP43

---

# E

# Compliance

This section contains the following topics:

- *Overview on page 172*
- *European R&TTE Directive on page 172*
- *EMC and safety notices on page 175*
- *FCC compliance on page 179*
- *IC certification on page 180*
- *RCM approval on page 180*

# Overview

This section describes how to ensure the Envoy Transceiver complies with the European R&TTE Directive 1999/5/EC.

This section also contains the requirements for FCC, IC, and RCM.

## European R&TTE Directive

The Envoy Transceiver has been tested and complies with the following standards and requirements (articles of the R&TTE Directive):

- Article 3.1b: ETSI EN 301 489-1 V1.9.2
- Article 3.1b: ETSI EN 301 489-15 V1.2.1
- Article 3.2: Australian type approval according to AS/NZS 4770:2000 + transmitter RSE tests to the limits specified in Annex 6, section 6.1.2 of CEPT/ERC/Recommendation 74-01E
- Article 3.1a: assessed against ICNIRP and FCC requirements
- Article 3.1a: (LVD) EN 60950-1:2006/AC:2011
- Article 3.1a: (MPE) EN 62311:2008

## Product marking and labelling

Any equipment supplied by Codan that satisfies these requirements is identified by the **CE 0889**  markings displayed on the product.



## Radiation safety (EU installations only)

To ensure optimal transceiver performance and to avoid exposure to excessive electromagnetic fields, the antenna system must be installed according to the instructions provided.

**WARNING:** High voltages exist on the antenna during transmission and tuning. Do not touch the antenna during these activities. RF burns may result.

**WARNING:** Install the earthing system or counterpoise as directed to prevent RF burns from any metal part of the transceiver.

**WARNING:** You should not transmit from your transceiver or tune the antenna unless people are beyond the safe working distance for the installation.

The following safe working distances apply:

- anywhere within the vehicle cabin with an externally mounted mobile antenna
- 3 m unobstructed, of any part of a mobile antenna
- 2 m of any part of a fixed antenna

Safe working distance is based on continuous exposure to CW-type transmissions, as set out in the Human Exposure Restrictions standard EN 62311:2008.

## Declaration of Conformity and Notified Body Letter of Opinion

The CE Declaration of Conformity and Notified Body Letter of Opinion for this product are available upon request to Codan or a Codan-authorized supplier.

## Protection of the radio spectrum

**CAUTION:** Most countries restrict the use of HF radio communications equipment to certain frequencies and bandwidths and/or require such equipment to be licensed. It is the user's responsibility to check the specific requirements with the appropriate communications authorities. Some options may vary the stated compliance. If necessary, contact Codan for more information.

The receive and transmit frequencies may be any frequencies within the HF range, however, the transmit frequencies can only be those allocated to you by the relevant government authority in your country.

Spectral regulations may require the TxD option to be installed in the transceiver. In this case, you cannot add channels with new transmit frequencies. You can, however, add receive-only channels, and channels with the same transmit frequency as an existing channel. If the TxP option is installed in the transceiver, you cannot add channels.

---

# EMC and safety notices

## Radiation safety (non-EU installations)

To ensure optimal transceiver performance and to avoid exposure to excessive electromagnetic fields, the antenna system must be installed according to the instructions provided.

**WARNING:** High voltages exist on the antenna during transmission and tuning. Do not touch the antenna during these activities. RF burns may result.

**WARNING:** Install the grounding system or counterpoise as directed to prevent RF burns from any metal part of the transceiver.

**WARNING:** You should not transmit from your transceiver or tune the antenna unless people are beyond the safe working distance for the installation.

The following safe working distances apply:

- anywhere within the vehicle cabin with an externally mounted mobile antenna
- 1.8 m (6 ft) unobstructed, of any part of a mobile antenna
- 2 m (7 ft) of any part of a fixed antenna in a data installation of up to 125 W output
- 5 m (17 ft) of any part of a fixed antenna in a data installation of up to 1 kW output

Safe working distance is based on continuous exposure to CW-type transmissions, as set out in the ICNIRP Exposure Guidelines (1998) for occupational exposure. Safe working distance can be reduced with normal voice communication.

## Sécurité des radiations (installations non-EU)

Pour assurer la performance optimale de l'émetteur-récepteur et pour éviter une exposition excessive aux champs électromagnétiques, le système d'antenne doit être déployé selon les instructions fournies.

**ATTENTION :** De hautes tensions RF sont présentes au cours de la transmission et de la syntonisation. Ne touchez pas l'antenne pendant ces activités, au risque de vous brûler.

**ATTENTION :** Installez le système de prise de terre ou le contrepois comme prescrit pour éviter toute brûlure RF au contact des pièces métalliques de l'émetteur-récepteur.

**ATTENTION :** Evitez d'émettre à partir de votre émetteur-récepteur onde syntoniser l'antenne si quelqu'un se trouve à moins de la distance de sécurité.

Les distances de sécurité suivantes sont applicables :

- à l'intérieur de la cabine d'un véhicule sur lequel une antenne mobile est déployée
- 1,8 m sans obstruction, de n'importe quelle partie de l'antenne mobile
- 2 m de n'importe quelle partie de l'antenne fixe dans une installation de données dont la sortie peut atteindre 125 W
- 5 m de n'importe quelle partie de l'antenne fixe dans une installation de données dont la sortie peut atteindre 1 kW

La distance de sécurité du travail se base sur une exposition continue aux transmissions de type onde entretenue, telle qu'établie dans les Lignes directives d'exposition de l'ICNIRP (1998) pour l'exposition au travail. La distance de sécurité du travail peut être réduite dans le cas de communications vocales normales.

## EMC

**CAUTION:** If it is necessary to remove the covers at any stage, they must be refitted correctly before using the equipment.

To ensure that compliance with the EMC Directive is maintained.

- Use standard shielded cables supplied from Codan (where applicable).
- Ensure the covers for the equipment are fitted correctly.

## Electrical safety

To ensure compliance with the European Low Voltage Directive is maintained, you must install and use the Envoy Transceiver in accordance with the instructions in the Envoy Transceiver Getting Started Guide and the Envoy Transceiver Reference Manual.

When using equipment that is connected directly to the AC mains these precautions must be followed and checked before applying an AC mains supply to the unit.

To ensure electrical safety:

- Use the standard AC mains cable supplied.
- Ensure the covers for the equipment are fitted correctly.

**CAUTION:** If it is necessary for a qualified electronics technician to remove the covers during servicing, they must be refitted correctly before using the equipment.



**WARNING:** A protective earth connection must be included in the mains wiring to the 3020 Transceiver Supply.

**WARNING:** The protective cover must always be fitted when the 3020 Transceiver Supply is connected to the AC mains.

## Earth symbols

Chassis earth connection points are provided on the Envoy Transceiver and 3020 Transceiver Supply. A protective earth is provided in the AC mains wiring of the 3020 Transceiver Supply. This protective earth must be connected at the AC mains supply outlet. The symbols shown below are used to identify the earths on the equipment.

**Table 11:** Earth symbols

Symbol	Meaning
	Chassis earth
	Protective earth

---

# FCC compliance

## FCC Part 90 certification

The Envoy Transceiver has been tested and certified to FCC Part 90 (FCC identifier code DYY2210).

## FCC Part 15 compliance

Any modifications made to the Envoy Transceiver and 3020 Transceiver Supply that are not approved by the party responsible for compliance may void your equipment's compliance under Part 15 of the FCC rules.

The Envoy Transceiver and 3020 Transceiver Supply have been tested and found to comply with the limits for a Class B device, pursuant to Part 15 of the FCC rules. These limits are designed to provide reasonable protection against harmful interference in a residential installation. This equipment generates, uses and can radiate radio frequency energy and, if not installed and used in accordance with the instructions, may cause harmful interference to radio communications. However, there is no guarantee that interference will not occur in a particular installation. If this equipment does cause harmful interference to radio or television reception, which can be determined by switching the equipment off and on, the user is encouraged to try to correct the interference by one or more of the following measures:

- reorient or relocate the receiving antenna
- increase the separation between the equipment and receiver
- connect the equipment into an outlet on a circuit different from that to which the receiver is connected
- consult the dealer or an experienced radio/TV technician for help

# IC certification

## Product markings and labelling

The Envoy Transceiver is certified to IC standards (IC identifier 1029A-1).

L'émetteur-récepteur Envoy est certifié conforme aux normes IC (Code d'identification IC : 1029A-1).

## RCM approval

The Envoy Transceiver meets the requirements of the Australian Communications and Media Authority: Radiocommunications (MF and HF equipment—Land Mobile Service) Standard 2003 (AS/NZS 4770) and Radiocommunications (HF CB and Handphone Equipment) Standard 2008 (AS/NZ 4355).



---

# Index

## Numerics

- 2.4 kbit/s Data Modem
  - typical station 85
- 2220 Handset 3
- 2221 Handset 5
  - entering text 144
- 2230 Desk Console 7

## A

- advanced view 132
- AES-256 digital voice encryptor
  - switching on and off 69
- antenna
  - fixed
    - earthing 167
    - manual tune 10
  - mobile
    - earthing 161
  - selecting 29

## B

- basic view 132
- brightness
  - setting 48

## C

- call
  - adding to contact
    - Send Position 119
  - adding from the Call Log/Call History/Last Heard Log 125
  - adding to contact
    - Channel Test 25, 119
    - Emergency 25, 119

- Get Position 25, 119
    - Message 26, 120
    - Phone 28, 122
    - Selective 25, 119
    - Send Position 25
  - from Emergency key 8
  - incoming pop-up 60
  - making
    - Message 56
    - Selective 54
  - missed
    - viewing 61
  - receiving 60
  - to a contact 50
- Call History
  - toggle 12
- call information
  - structure 154
- call lock
  - overriding 64
- channel
  - adding 21
  - capacity 169
  - finding 37, 40
  - screen 33
  - selecting 37
- channel group
  - select 12
  - toggle 12
- Channel Test call
  - adding to contact 25, 119
- character-entry mode
  - selecting 12
- check box
  - selecting/deselecting 147

- 
- clarifier 10
  - compliance 171
    - EMC and safety notices
      - earth symbols 178
      - electrical safety 177
      - EMC 177
      - radiation safety (non-EU) 175
      - sécurité des radiations (non-EU) 176
    - FCC 179
    - IC certification 180
    - overview 172
    - R&TTE 172
      - declaration of conformity and notified body letter of opinion 173
      - product marking and labelling 172
      - protection of the radio spectrum 174
      - radiation safety (EU only) 173
    - RCM approval 180
    - safe working distance 173, 175
  - connection
    - types 21
  - contact
    - adding 24, 118
    - adding Channel Test call 25, 119
    - adding Emergency call 25, 119
    - adding from the Call Log/Call History/Last Heard Log 125
    - adding Get Position call 25, 119
    - adding Message call 26, 120
    - adding Phone call 28, 122
    - adding Selective call 25, 119
    - adding Send Position call 25, 119
  - control point
    - power-down function 21
  - cooling 169
  - crosspatch
    - operating mode 10
    - changing 113
    - overview 111
  - D**
  - date
    - setting 19, 47
  - deleting items 138
  - desk console
    - size 170
    - weight 170
  - digital voice
    - overview 66
    - switching on and off 69
  - digital voice mute 68
    - selecting 73
  - digital voice rate 67
    - selecting 72
  - display
    - brightness 48
  - E**
  - Easitalk 11
  - editing items 138
  - Emergency call
    - adding to contact 25, 119
  - encryptor
    - switching on/off 100
  - F**
  - firmware upgrade
    - USB stick 114
  - fixed station 162
  - free-tune
    - receive 10
  - frequency
    - range 169
  - G**
  - Get Position call
    - adding to contact 25, 119
  - GPS 11
    - information
      - using 82
  - GPS position
    - saving as a waypoint 75
  - H**
  - handset
    - size 170
    - weight 170
  - I**
  - icon
    - selecting 137
  - input language
    - selecting 12
    - 2220/2230 140
    - 2221 144
  - K**
  - keypad 8

**L**

- language
  - selecting 19

**M**

- menu bar
  - selecting an option 138
- menu structure
  - navigating 127
- Message call
  - adding to contact 26, 120
  - making 56
- microphone
  - using 46
- MIL/STANAG 2G Data 91
  - sending email 95
  - typical station 91
- missed call
  - viewing 61
- mobile station 156
- mode
  - changing 37
  - selecting 10
- modem
  - viewing performance 88
- moving items 138, 149
- multiple control points
  - calling 64
- mute 44
  - switching on or off 44
- mute type
  - selecting 45

**O**

- operating modes 169
- order of items in a list
  - changing 149

**P**

- peripheral
  - selecting 30
- Phone call
  - adding to contact 28, 122
- power-down function
  - setting 21
- program via USB stick
  - profile 114
  - secure keys 114

**R**

- read to USB stick
  - profile 114
- relative humidity 169
- RFU
  - size 170
  - weight 170
- RM50e HF Data Modem 96
  - sending email 98
  - typical station 97

**S**

- scanning 41
  - pausing 42
  - switching on or off 42
- scrambler
  - privacy code
    - changing 107
  - switching on/off 100
- screen
  - channel 33
- secure
  - session PIN
    - entering 105
    - standby mode 104
- secure key
  - adding 108
  - selecting 106
- secure mode 11
- Selective call
  - adding to contact 25, 119
  - making 54
- self address
  - entering 23
- Send Position call
  - adding to contact 25, 119
- size
  - desk console 170
  - handset 170
  - RFU 170
- slider
  - moving 148
- special character
  - entering 11, 143
- station
  - fixed 162
    - cables 164
    - earthing 167
  - mobile 156
    - cables 157
    - connecting control cable to automatic

- tuning antenna 160
- connecting to battery power supply 160
- earthing 161
- mounting 157
- mounting handset and speaker connector 158
- mounting handset cradle 157
- mounting RF unit 158
- mounting speaker 158

- wizard
  - adding channels to a scan table 23
  - overview 16
  - starting 18
- word
  - finding 134

## T

- temperature 169
- text
  - editing 140
- time
  - setting 19, 47
- transceiver
  - installing 155
  - operating 31
  - switching off 32
  - switching on 32

## U

- USB stick
  - selecting tasks 114
- user information
  - structure 152

## V

- value
  - finding 134
- view
  - advanced 132
  - basic 132
  - overview 132
  - switching between 133

## W

- waypoint
  - adding 79
  - finding 81
  - selecting 75
  - updating
    - from a contact 77
    - from Call History 76
  - viewing 82
- weight
  - desk console 170
  - handset 170
  - RFU 170



**CODAN**  
RADIO COMMUNICATIONS

[www.codanradio.com](http://www.codanradio.com)



ASIA PACIFIC (Head Office)

Codan Limited  
81 Graves Street  
Newton SA 5074  
AUSTRALIA

T: +61 8 8305 0311

F: +61 8 8305 0411

[asiasales@codanradio.com](mailto:asiasales@codanradio.com)